

SMV CHEMICALS LAB EQUIPMENTS

CATALOGUE - 2018-19



ISO 9001: 2015



SMV –A-1 Reduction Adapters

Cat. No.	Socket	Cone	Price
001	10/19	14/23	170.00
002	14/23	19/26	180.00
003	14/23	24/29	300.00
004	14/23	29/32	350.00
005	19/26	24/29	300.00
006	19/26	29/32	350.00
007	19/26	34/35	500.00
008	19/26	45/40	900.00
009	19/26	55/44	900.00
010	24/29	29/32	500.00
011	24/29	34/35	900.00
012	24/29	45/40	900.00
013	24/29	55/44	1200.00
014	29/32	34/35	1200.00
015	29/32	45/40	1200.00
016	29/32	55/44	1200.00
017	34/35	45/40	1200.00
018	34/35	55/44	1200.00
019	40/38	55/44	1200.00
020	45/40	55/44	1200.00

SMV – A-2 Expansion Adapters

Cat. No.	Socket	Cone	Price
021	14/23	10/13	200.00
022	19/26	14/23	245.00
023	24/29	19/26	450.00
024	24/29	14/23	450.00
025	29/32	24/29	450.00
026	29/32	19/26	450.00
027	29/32	14/23	450.00
028	34/35	29/32	800.00
029	34/35	24/29	800.00
030	34/35	19/26	800.00
031	40/38	14/23	800.00
032	40/38	19/26	800.00
033	40/38	24/29	800.00
034	40/38	29/32	800.00
035	40/38	34/35	800.00
036	45/40	34/35	800.00
037	45/40	29/32	1250.00
038	45/40	24/29	1250.00
039	55/44	45/40	1250.00
040	55/44	34/35	1250.00



A-1



A-2

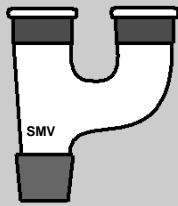

A-3

SMV – A-3 Multi Adapters, Two Necks Parallel (Y-Bend)

Cat. No.	Socket	Cone	Price
041	10/19	10/19	400.00
042	14/23	14/23	400.00
043	19/26	19/26	450.00
044	19/26	24/29	550.00
045	19/26	34/35	650.00
046	24/29	24/29	600.00
047	29/32	29/32	980.00

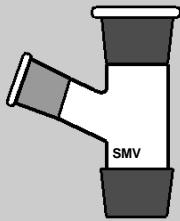

A-4

SMV – A-4 Multi Adapter, Two Necks One Vertical and One Angle

Cat. No.	Socket	Cone	Price
048	19/23	19/23	273.00
049	19/23	24/29	273.00
050	24/29	24/29	308.00
051	24/29	29/32	372.00
052	24/29	34/35	390.00
053	24/29	40/44	435.00
054	29/32	29/32	469.00
055	29/32	34/35	469.00
056	34/35	34/35	489.00

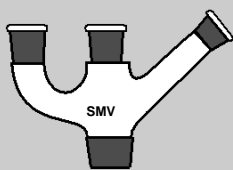

A-5

SMV – A-5 Multi Adapter, Three Necks Two Parallel and one Angle

Cat. No.	Socket	Angle Neck	Cone	Price
	Neck Socket	Socket		
057	14/23	14/23	19/26	390.00
058	19/26	14/23	24/29	450.00
059	19/26	19/26	24/29	490.00
060	19/26	19/26	29/32	520.00
061	19/26	19/26	34/35	625.00
062	19/26	19/26	55/44	900.00
063	24/29	24/29	34/35	1,000.00
064	29/32	29/32	34/35	1,200.00
065	34/35	34/35	55/44	1,450.00

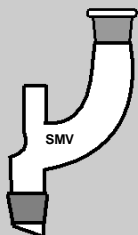

A-6

SMV – A-6 Swan Neck Adapters, For Use with Air leak Tube

Cat. No.	Socket	Cone	Price
066	14/23	14/23	200.00
067	19/26	19/26	258.00
068	19/26	24/26	279.00
069	24/29	24/29	321.00

SMV – A-7 Adapters With 'T' Connection

Cat. No.	Socket	Cone	Price
070	14/26	14/26	180.00
071	14/26	19/26	180.00
072	14/26	24/29	220.00
073	19/26	19/26	220.00
074	19/26	24/29	220.00
075	19/26	34/35	340.00
076	24/29	34/35	399.00

SMV – A-8 Adapters Straight Connection Plain

Cat. No.	Cone	Price
077	10/19	190.00
078	14/23	250.00
079	19/26	300.00
080	24/29	350.00
081	29/32	450.00
082	34/35	500.00

SMV – A-9 Cone Adapter, Right Angle Connection, Plain

Cat. No.	Cone	Price
083	10/19	190.00
084	14/23	250.00
085	19/26	300.00
086	24/29	350.00
087	29/32	450.00
088	34/35	500.00

SMV – A-10 Cone Adapters, Straight Connection with Glass Stopcock

Cat. No.	Cone	Price
089	14/23	500.00
090	19/26	520.00
091	24/29	550.00
092	29/32	880.00
093	34/35	1200.00

SMV – A-11 Cone Adapter, Right Angle Connection with Stopcock Glass

Cat. No.	Cone	Price
094	14/23	500.00
095	19/26	520.00
096	24/29	880.00
097	29/32	1200.00

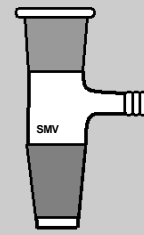
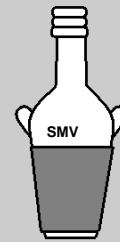
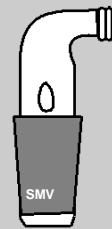
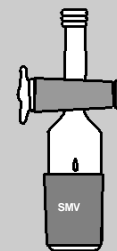
**A-7****A-8****A-9****A-10****A-11**

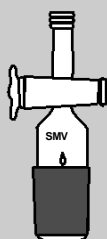

A-12



A-13

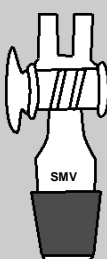

A-14

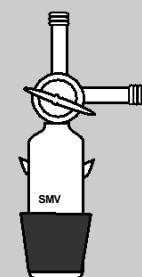

A-15

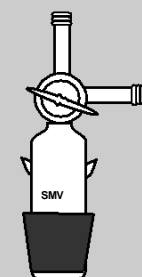

A-16

SMV – A-12 Cone Adapter, Straight Connection with PTFE Stopcock

Cat. No.	Cone	Price
098	14/23	900.00
099	19/26	922.00
100	24/29	945.00
101	29/32	970.00
102	34/35	1200.00

SMV – A-13 Cone Adapter, Right Angle Connection With PTFE Stopcock

Cat. No.	Cone	Price
103	14/23	900.00
104	19/26	922.00
105	24/29	945.00
106	29/32	970.00
106A	34/35	1200.00

SMV – A-14 Cone Adapter, Double Oblique Glass Stopcock

Cat. No.	Cone	Price
107	14/23	2,250.00
108	19/26	2,250.00
109	24/29	2,250.00
110	29/32	2,250.00
111	34/35	2,250.00

SMV – A-15 Cone Adapter T Connection with PTFE Stop Cock

Cat. No.	Cone	Price
112	14/23	1,750.00
113	19/26	1,750.00
114	24/29	1,750.00
115	29/32	1,750.00
116	34/35	1,750.00

SMV – A-16 Cone Adapter T Connection with Glass Stopcock

Cat. No.	Cone	Price
117	14/23	1,750.00
118	19/26	1,750.00
119	24/29	1,750.00
120	29/32	1,750.00
121	34/35	1,750.00

SMV – A-17 Receiver Adapters, Plain Bend, Long

Cat. No.	Cone	Price
122	10/19	102.00
123	14/23	110.00
124	19/26	190.00
125	24/29	220.00
126	29/32	240.00
127	34/35	245.00

SMV – A-18 Receiver Adapters, Straight Delivery

Cat. No.	Cone	Price
128	14/23	102.00
129	19/26	110.00
130	24/29	113.00
131	29/32	115.00
132	34/35	245.00
133	45/40	293.00

SMV – A-19 Receiver Adapters, Plain Bend, Socket To cone

Cat. No.	Socket	Cone	Price
134	14/23	14/23	127.00
135	19/26	19/26	174.00
136	24/29	34/35	394.00
137	19/26	24/29	217.00
138	24/29	19/26	217.00
139	24/29	24/29	217.00
140	29/32	24/29	217.00
141	29/32	29/32	394.00
142	29/32	34/35	394.00

SMV – A-20 Receiver Adapters, Bent With Vent

Cat. No.	Socket	Cone	Price
143	10/19	10/19	135.00
144	14/23	14/23	155.00
145	19/26	19/26	160.00
146	24/29	19/26	165.00
147	24/29	24/29	231.00
148	29/32	29/32	520.00

SMV – A-21 Receiver (Vacuum Receiving Bend)

Cat. No.	Socket	Cone	Price
149	14/23	14/23	252.00
150	14/23	19/26	300.00
151	19/26	19/26	450.00
152	19/26	24/29	450.00
153	24/29	19/26	450.00
154	24/29	24/29	550.00
155	29/32	29/32	600.00
156	34/35	24/29	900.00
157	34/35	34/35	1,200.00

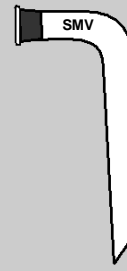

A-17

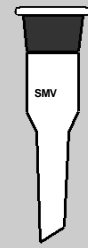

A-18

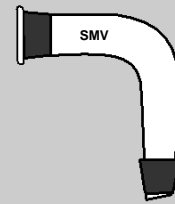

A-19

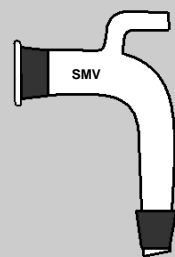

A-20

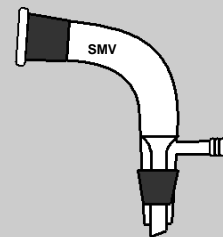

A-21

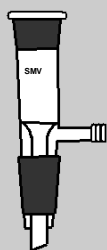

A-22

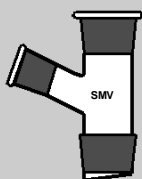

A-23



A-24

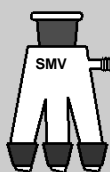

A-25



A-26



A-27

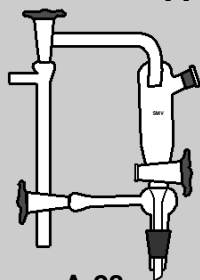

A-28

SMV – A-22 Receiver Adapters, Straight With Vacuum Connection

Cat. No.	Socket	Cone	Price
158	14/23	14/23	195.00
159	14/23	19/26	200.00
160	19/26	19/26	230.00
161	24/29	14/23	230.00
162	24/29	19/26	295.00
163	19/26	24/29	295.00
164	24/29	24/29	324.00

SMV – A-23 Receiver Adapters, Bent With Socket Connection

Cat. No.	Socket	Cone	Price
165	14/29	14/23	273.00
166	19/26	19/26	336.00
167	19/26	24/29	358.00
168	24/29	24/29	421.00

SMV – A-24 Receiver Adapters, Bent With Multiple Connection (PIG)

Cat. No.	Socket	Cone	Price
169	10/19	10/19	535.00
170	14/23	14/23	1,600.00
171	19/26	14/23	1,600.00
172	19/29	19/26	1,800.00
173	24/29	14/23	1,800.00
174	24/29	19/26	2,100.00
175	29/32	14/23	2,100.00

SMV – A-25 Receiver Adapters, Multi-Limb, Vacuum

Cat. No.	Socket	Cone	Price
176	19/26	14/23	1,250.00
177	24/29	19/23	1,250.00
178	24/29	24/29	1,250.00

SMV – A-26 Receiver Adapters, Vertical Delivery

Cat. No.	Socket	Cone	Price
179	19/26	19/26	264.00
180	24/29	24/29	293.00

SMV – A-27 Receiver Adapters, Sloping Delivery

Cat. No.	Socket	Cone	Price
181	19/26	19/26	264.00
182	24/29	24/29	293.00

SMV – A-28 Intermediate Receiver Adapters (PERKIN)

Cat. No.	Socket	Cone	Cap.ml	Price
183	14/23	14/23	10	6,500.00
184	19/26	19/26	32	6,500.00
185	19/26	24/29	32	6,500.00
186	24/29	24/29	32	6,500.00

SMV – A-29 Recovery Bend, Sloping (L-Bends)

Cat. No.	Flask Cone	Cond.Cone	Price
187	14/23	14/23	165.00
188	19/26	19/26	204.00
189	24/29	14/23	268.00
190	24/29	19/26	268.00
191	24/29	24/29	268.00
192	29/32	19/26	358.00
193	29/32	29/32	358.00
194	34/35	19/26	746.00
195	34/35	24/29	746.00
196	34/35	34/35	746.00

SMV – A-30 Goose Neck with Vacuum Connection

Cat. No.	Flask Cone	Cond.Cone	Price
197	14/23	14/23	400.00
198	14/23	19/26	400.00
199	19/26	19/26	500.00
200	19/26	24/29	500.00
201	24/29	24/29	500.00

SMV – A-31 Recovery Bend Vertical

Cat. No.	Flask Cone	Cond.Cone	Price
202	14/23	14/23	200.00
203	19/26	19/26	600.00
204	24/29	19/26	600.00
205	24/29	24/29	600.00
206	29/32	29/32	600.00
207	34/35	34/35	1,100.00

SMV – A-32 Plain Still heads, Sloping (Distillation Head T-Bend)

C.No.	Flask Cone	Cond.Cone	Socket	Price
208	10/13	10/13	10/19	222.00
209	14/23	14/23	14/23	350.00
210	19/26	19/26	14/23	490.00
211	19/26	19/26	19/26	490.00
212	24/29	19/26	14/23	490.00
213	24/29	24/29	14/23	550.00
214	29/32	19/26	14/23	500.00
215	29/32	24/29	14/23	600.00
216	29/32	29/32	14/23	690.00
217	34/35	19/26	14/23	690.00
218	34/35	24/29	14/23	700.00
219	34/35	34/35	14/23	1600.00

SMV – A-33 Claisen Heads, Sloping

Cat. No.	Flask Cone	Cond.Cone	Socket	Price
220	14/23	14/23	14/23	600.00
221	19/26	19/26	14/23	600.00
222	24/29	19/26	14/23	600.00
223	24/29	24/29	14/23	600.00
224	29/32	29/32	14/23	900.00
225	34/35	19/26	14/23	999.00

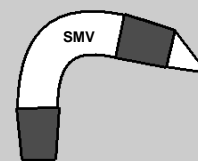

A-29

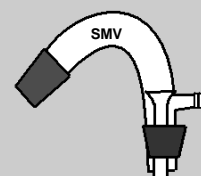

A-30

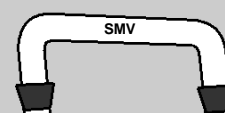

A-31

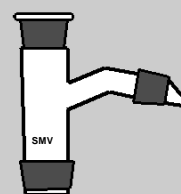

A-32

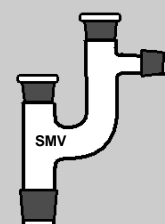

A-33

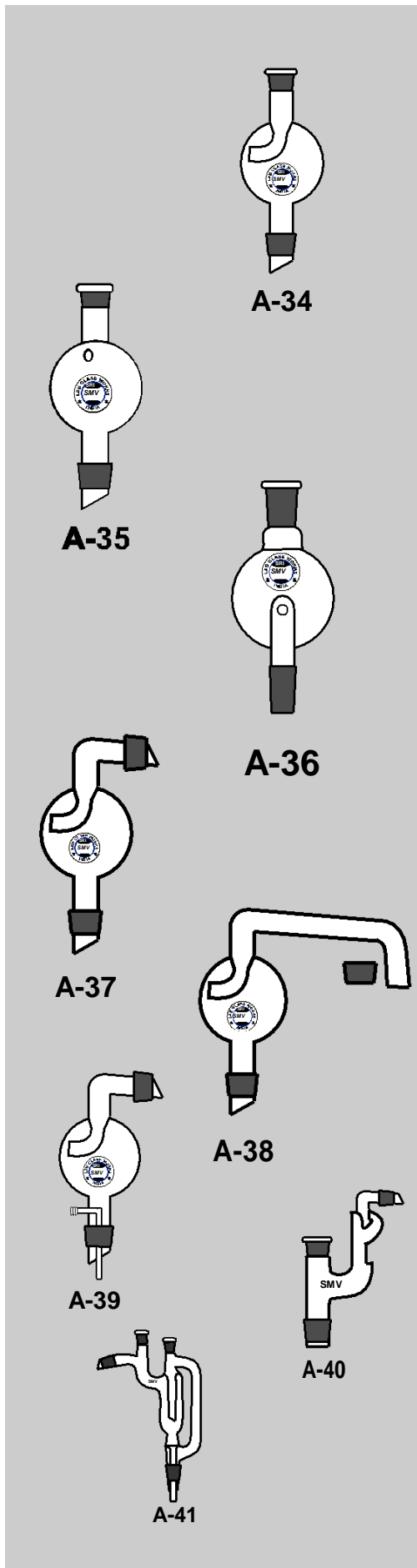

SMV – A-34 Splash Head Adapter

Cat. No.	Socket	Cone	Price
226	14/23	14/23	421.00
227	19/26	24/29	435.00
228	24/29	24/29	435.00

SMV – A-35 Splash Head Adapters, Kjeldhal Trap

Cat. No.	Socket	Cone	Price
229	19/26	24/29	486.00
230	24/29	24/29	502.00
231	24/29	19/26	495.00
232	29/32	24/29	511.00
233	29/32	19/26	615.00
234	29/32	14/23	615.00

SMV – A-36 Splash Head Adapters for rotovaps anti claimp without return hole.

Cat. No.	Socket	Cone	Price
235	29/32	14/23	885.00
236	29/32	19/26	934.00
237	29/32	24/29	1,002.00
238	29/32	29/32	1,176.00

SMV – A-37 Splash Heads, Sloping

Cat. No.	Flask Cone	Cond.Cone	Price
239	14/23	14/23	655.00
240	19/26	19/26	655.00
241	24/29	19/26	655.00
242	24/29	24/29	655.00
243	29/32	19/26	655.00
244	29/32	29/32	650.00
245	34/35	19/26	655.00
246	34/35	24/29	655.00
247	34/35	34/35	1,095.00

SMV – A-38 Splash Heads, Vertical

Cat. No.	Flask Cone	Cond.Cone	Price
248	19/26	19/26	600.00
249	24/29	19/26	600.00
250	24/29	24/29	600.00

SMV – A-39 Steam Distillation Heads, Sloping

Cat. No.	Flask Cone	Cond.Cone	Price
251	24/29	19/26	900.00
252	34/35	19/26	950.00

SMV – A-40 Splash Head, Double Bulb, Sloping

Cat. No.	Flask Cone	Cond.Cone	Socket	Price
253	24/29	19/26	14/23	1,200.00

SMV – A-41 Anti-Foaming Splash Head, Sloping

Cat. No.	Flask Cone	Cond.Cone	Socket	Price
254	24/29	19/26	14/23	2,000.00

SMV – A-42 Thermometer Pocket, Close end

Cat. No.	Cone	R.B.Capacity	Price
255	14/23	100 ml	112.00
256	19/26	100 ml	120.00
257	14/23	250 ml	112.00
258	19/26	250 ml	170.00
259	24/29	250 ml	220.00
260	19/26	500 ml	170.00
261	24/29	500 ml	220.00
262	19/26	1000 ml	170.00
263	24/29	1000 ml	220.00
264	19/26	2 ltr	170.00
265	24/29	2 ltr	220.00
266	19/26	3 ltr	240.00
267	24/29	3 ltr	250.00
268	24/29	5 ltr	274.00
269	24/29	10 ltr	290.00
270	29/32	10 ltr	309.00
271	24/29	20 ltr	300.00
272	29/32	20 ltr	381.00
273	34/35	20 ltr	386.00

SMV – A-43 Thermometer Pocket, Closed end for still heads (T-Bend)

Cat. No.	Cone	Price
274	14/23	150.00

SMV – A-44 AIR/Steam Inlet Tubes, Straight or Bent (Gas Inlet Tubes)

Cat. No.	Cone	R.B.Capacity	Price
275	14/23	100 ml	140.00
276	19/26	100 ml	200.00
277	14/23	250 ml	170.00
278	19/26	250 ml	200.00
279	24/29	250 ml	240.00
280	19/26	500 ml	200.00
281	24/29	500 ml	240.00
282	19/26	1 ltr	200.00
283	24/29	1 ltr	240.00
284	19/26	2 ltr	200.00
285	24/29	2 ltr	240.00
286	19/26	3 ltr	240.00
287	24/29	3 ltr	250.00
288	24/29	5 ltr	290.00
289	24/29	10 ltr	300.00
290	29/32	10 ltr	300.00
291	24/29	20 ltr	300.00
292	29/32	20 ltr	340.00
293	34/35	20 ltr	350.00

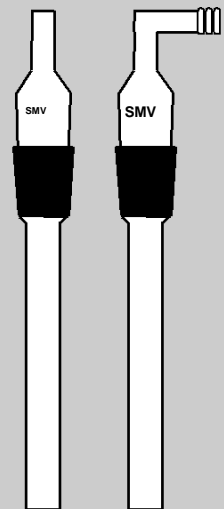
**A-42****A-43****A-44**

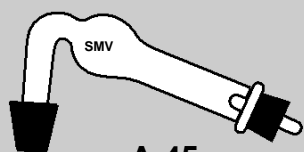

A-45

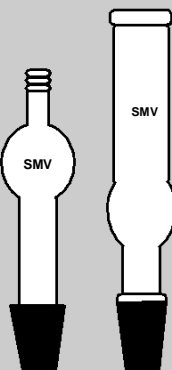

A-46

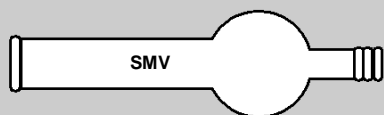

A-47

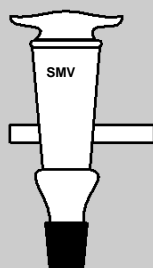

A-48

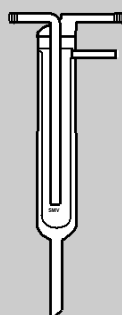

A-49



A-50

SMV – A-45 Drying Tubes Angled

Cat. No.	Cone	Price
294	10/29	108.00
295	14/23	160.00
296	19/26	170.00
297	24/29	190.00
298	29/32	250.00
299	34/35	280.00

SMV – A-46 Drying Tubes Straight

Cat. No.	Cone	Price
300	10/29	108.00
301	14/23	108.00
302	19/26	120.00
303	24/29	130.00
304	29/32	198.00
305	34/35	240.00

SMV – A-47 Calcium Chloride Tubes, Straight With Line Bulb

Cat. No.	Price
306	100 x 8 mm 140.00
307	125 x 8 mm 150.00
308	150 x 8 mm 160.00

SMV – A-48 Tube Adapters for Vacuum Release

Cat. No.	Cone	Price
309	19/26	500.00
310	24/29	520.00
311	19/26	500.00
312	24/29	520.00

SMV – A-49 Condensers, Hopkin (Reflux) Cone Size

Cat. No.	Cone	Length mm	Price
313	19/24/29	300 30	700.00
314	19/24/29	400 30	900.00

SMV – A-50 Condensers, Air

Cat. No.	Joint	Length mm	Price
315	14/23	200	250.00
316	19/26	200	350.00
317	19/26	300	350.00
318	19/26	400	350.00
319	19/26	500	350.00
320	19/26	600	600.00
321	24/29	200	350.00
322	24/29	300	450.00
323	24/29	400	490.00
324	24/29	600	670.00
325	34/35	300	600.00
326	34/35	450	650.00
327	34/39	600	750.00
328	34/35	1000	1,500.00

SMV – A-51 Condenser, Liebig (Plain)

Cat. No.	Joint	Length mm	Price
329	14/23	100	250.00
330	19/26	100	250.00
331	14/23	150	290.00
332	19/26	150	386.00
333	19/26	300	450.00
334	19/26	400	386.00
335	19/26	500	456.00
336	24/29	150	330.00
337	24/29	200	330.00
338	24/29	300	490.00
339	24/29	400	386.00
340	24/29	500	468.00
341	29/32	400	410.00
342	29/32	500	477.00
343	34/35	500	1,200.00

SMV – A-52 Condensers, Liebig, Vertical

Cat. No.	Cone	Length mm	Price
344	19/26	300	285.00
345	19/26	400	355.00
346	19/26	500	427.00
347	24/29	400	360.00
348	24/29	500	440.00

SMV – A-53 Condensers, Double Surface (DAVIES)

Cat. No.	Joint	Length mm	Price
349	14/23	100	440.00
350	14/23	200	441.00
351	19/26	200	756.00
352	19/26	300	970.00
353	24/29	200	750.00
354	24/29	300	1,200.00
355	34/35	450	1,568.00
356	24/29	600	1,358.00
357	34/35	600	1,828.00

SMV – A-54 Condensers, Double Surface (VERTICAL)

Cat. No.	Cone	Length mm	Price
358	19/26	200	620.00
359	24/29	200	632.00
360	29/32	200	682.00
361	34/35	200	742.00
362	40/38	300	950.00
363	45/40	300	1,026.00
364	45/40	300	1,206.00

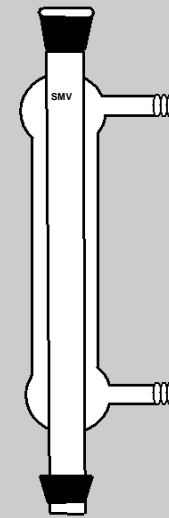

A-51

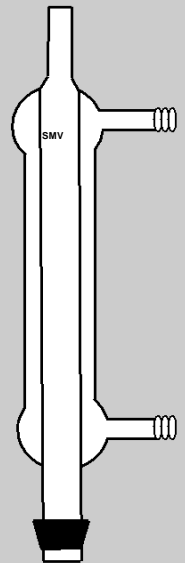

A-52

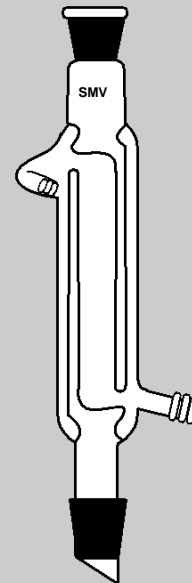

A-53

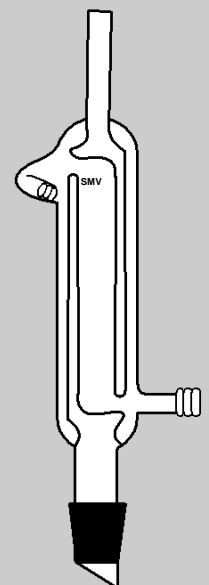

A-54

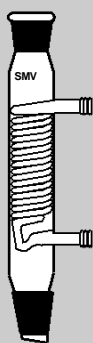

A-55

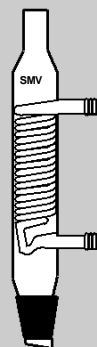

A-56

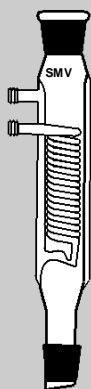

A-57

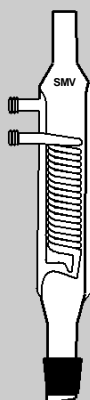

A-58

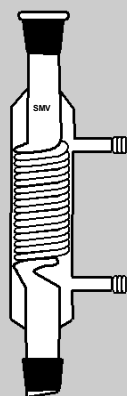

A-59

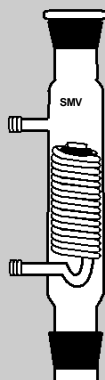

A-60

SMV – A-55 Condensers, Coil (Graham)

Cat. No.	Joint	Length mm	Price
365	19/26	150	430.00
366	19/26	300	750.00
367	24/29	150	450.00
368	24/29	300	770.00
369	29/32	300	800.00
371	34/35	300	1,000.00
372	34/35	450	1,200.00

SMV – A-56 Condensers, Coil (Graham), Vertical

Cat. No.	Joint	Length mm	Price
373	29/32	150	500.00
374	24/29	300	520.00
375	34/35	300	650.00
376	34/35	450	793.00

SMV – A-57 Condenser, Jacketed Coil

Cat. No.	Joint	Length mm	Price
377	19/26	150	982.00
378	24/29	150	1,017.00
379	29/32	150	1,105.00
380	29/32	300	1,973.00
381	34/35	300	2,234.00
382	34/35	450	2,379.00

SMV – A-58 Condensers, Jacketed Coil, Vertical

Cat. No.	Cone	Length mm	Price
383	34/35	150	1,285.00
384	34/35	300	2,186.00

SMV – A-59 Condenser, Coiled Distillate (PRODUCT COOLER)

Cat. No.	Joint	Length mm	Price
385	14/23	180	380.00
386	19/26	200	565.00
387	24/29	300	660.00
388	24/29	400	915.00
389	24/29	500	1,200.00
390	29/32	400	1,100.00
391	34/35	400	1,215.00
392	34/35	600	1,465.00

SMV – A-60 Condensers, Independent Double Coil

Cat. No.	Joint	Length mm	Price
393	19/26	200	1,290.00
394	24/29	200	1,298.00
395	24/29	300	1,700.00
396	34/35	300	1,815.00
397	34/35	450	1,997.00

SMV – A-61 Condenser, Combined Double Coil

Cat. No.	Joint	Length mm	Price
398	29/32	230	3,469.00
399	29/32	380	4,990.00
400	34/35	230	3,586.00
401	34/35	380	3,850.00
402	34/35	450	4,600.00

SMV – A-62 Condenser, Inland Revenue (THORPE)

Cat. No.	Joint	Length mm	Price
403	19/26	200	1,400.00
404	24/29	200	1,500.00
405	24/29	300	1,692.00

SMV – A-63 Condenser, Ether

Cat. No.	Socket	Cone	Length	Price
406	19/26	24/29	180	4,000.00

SMV – A-64 Condenser, Vertical Distillate

Cat. No.	Cone	Height mm	Price
407	34/35	350	2,600.00

SMV – A-65 Condenser, Immersion (COLD FINGER)

Cat. No.	Cone	Height mm	Price
408	19/26	100	300.00
409	24/29	200	573.00
410	29/32	200	678.00
411	34/35	250	888.00
412	55/44	300	1,245.00

SMV – A-66 Condensers, Allihn

Cat. No.	Joint	Length mm	Price
413	19/26	300	450.00
414	24/29	300	560.00
415	24/29	400	660.00
416	24/29	500	802.00
417	24/29	600	910.00

SMV – A-67 Condensers, Allihn, Vertical

Cat. No.	Cone	Length mm	Price
418	19/26	200	390.00
419	24/29	200	400.00
420	29/32	200	430.00
421	34/35	200	840.00
422	40/38	200	530.00
423	45/40	300	680.00
424	55/44	300	730.00

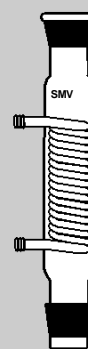

A-61

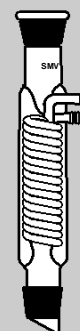

A-62

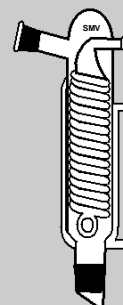

A-63

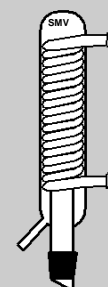

A-64

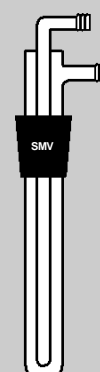

A-65



A-66



A-67

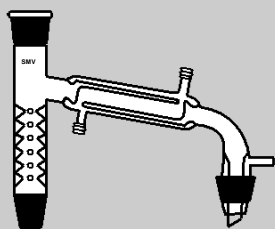

A-68

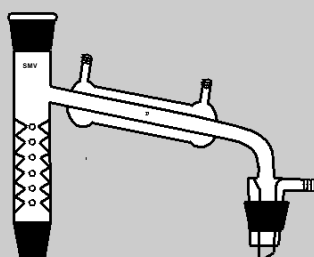

A-69

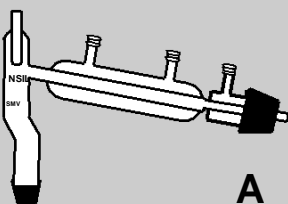

A

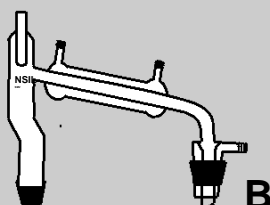

B

A-70

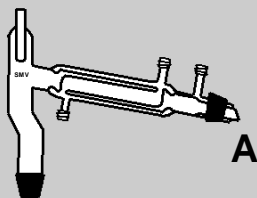

A

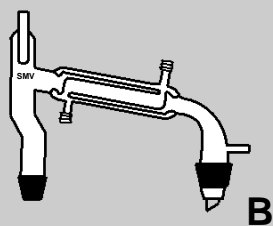

B

A-71

SMV – A-68 Condenser Distillation with Vigreux (DOUBLE SURFACE)

Cat. No.	Length mm	Joints	Price
425	100x50	14/23	1,300.00
426	100x50	19/26	1,300.00
427	150x50	19/26	1,500.00
428	150x100	19/26	1,500.00
429	200x160	19/26	1,900.00
430	250x160	19/26	1,900.00
431	100x50	24/29	1,300.00
432	150x50	24/29	1,500.00
433	150x100	24/29	1,500.00
434	200x160	24/29	1,900.00
435	250x160	24/29	2,000.00
436	250x200	24/29	2,200.00
437	300x250	24/29	2,400.00
438	200x150	29/32	2,400.00
439	300x250	29/32	3,500.00

SMV – A-69 Condenses Distillation With Vigreux Plain

Cat. No.	Length mm	Joints	Price
440	100x50	14/23	1,287.00
441	100x50	19/26	1,287.00
442	150x50	19/26	1,450.00
443	150x100	19/26	1,680.00
444	200x160	19/26	1,995.00
445	250x200	19/26	2,316.00
446	100x50	24/29	1,498.00
447	150x50	24/29	1,650.00
448	150x100	24/29	1,690.00
449	200x160	24/29	2,250.00
450	250x200	24/29	2,450.00
451	300x200	24/29	2,800.00
452	200x150	29/32	3,000.00
453	300x250	29/32	3,200.00

SMV – A-70 Short Path Condenser Plain

Cat. No.	Length mm	Joints	Price
454	100x55	14/23	1,500.00
455	100x55	19/26	1,500.00
456	100x55	24/29	1,500.00
457	150x55	14/23	1,500.00
458	150x55	19/26	2,000.00
459	150x55	24/29	2,000.00

V – A-71 Short Path Condenser Double Surface With Bent Vacuum Connection

Cat. No.	Length mm	Joints	Price
460	100x55	14/23	1,650.00
461	100x55	19/26	1,656.00
462	100x55	24/29	1,800.00
463	150x55	14/23	1,696.00
464	150x55	19/26	1,786.00

SMV – A-72 Chromatography Columns, Plain With Glass Stopcock

Cat. No.	Dia mm	Length mm	Price
466	15	200 (Medium Wall)	680.00
467	20	200 (Medium Wall)	720.00
468	20	300 (Medium Wall)	900.00
469	20	450 (Medium Wall)	940.00
470	25	200 (Medium Wall)	750.00
471	25	450 (Medium Wall)	850.00
472	30	300 (Medium Wall)	870.00
473	30	450 (Medium Wall)	920.00
474	30	600 (Medium Wall)	950.00
475	40	300 (Medium Wall)	980.00
476	40	450 (Medium Wall)	980.00
477	40	600 (Medium Wall)	1,200.00
478	40	1000 (Medium Wall)	1,400.00
479	50	450 (Medium Wall)	1,500.00
480	50	600 (Medium Wall)	2,000.00
481	50	1000 (Medium Wall)	2,500.00
482	60	600 (Medium Wall)	2,800.00
483	60	1000 (Medium Wall)	2,900.00
484	80	500 (Medium Wall)	3,000.00
485	80	1000 (Medium Wall)	3,900.00
486	100	500 (Medium Wall)	4,500.00
487	100	1000 (Medium Wall)	4,900.00
488	120	500 (Medium Wall)	5,000.00
489	120	1000 (Medium Wall)	7,000.00
490	150	500 (Medium Wall)	7,555.00
491	150	1000 (Medium Wall)	9,000.00

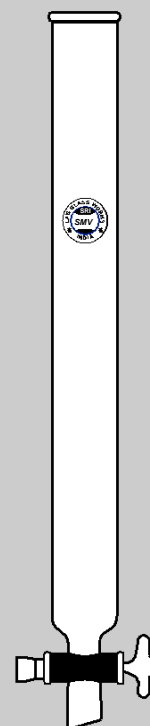

A-72

SMV – A-73 Chromatography Columns, Plain with Screw Cock

Cat. No.	Dia mm	Length mm	Price
492	15	200 (Medium Wall)	680.00
493	20	200 (Medium Wall)	720.00
494	20	300 (Medium Wall)	900.00
495	20	450 (Medium Wall)	940.00
496	25	200 (Medium Wall)	750.00
497	25	450 (Medium Wall)	850.00
498	30	300 (Medium Wall)	870.00
499	30	450 (Medium Wall)	920.00
500	30	600 (Medium Wall)	950.00
501	40	300 (Medium Wall)	980.00
502	40	450 (Medium Wall)	980.00
503	40	600 (Medium Wall)	1,200.00
504	40	1000 (Medium Wall)	1,400.00
505	50	450 (Medium Wall)	1,500.00
506	50	600 (Medium Wall)	2,000.00
507	50	1000 (Medium Wall)	2,500.00
508	60	600 (Medium Wall)	2,800.00
509	60	1000 (Medium Wall)	2,900.00
510	80	500 (Medium Wall)	3,000.00
511	80	1000 (Medium Wall)	3,900.00
512	100	500 (Medium Wall)	4,500.00
513	100	1000 (Medium Wall)	4,900.00
514	120	500 (Medium Wall)	5,000.00
515	120	1000 (Medium Wall)	7,000.00
516	150	500 (Medium Wall)	7,555.00
517	150	1000 (Medium Wall)	9,000.00



A-73

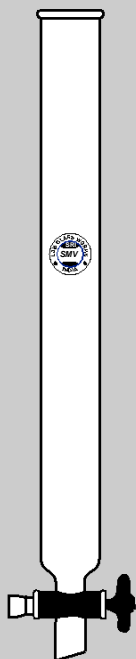

A-74



A-75

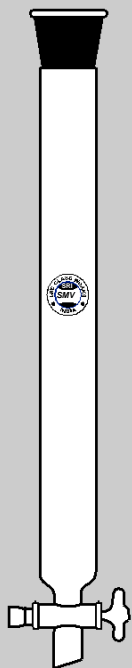

A-76

SMV – A-74 Chromatography Columns, Plain with PTFE Stopcock

Cat. No.	Dia/mm	Length mm	Price
518	20	300 (Medium Wall)	1,000.00
519	30	300 (Medium Wall)	1,200.00
520	30	600 (Medium Wall)	1,600.00
521	40	300 (Medium Wall)	1,644.00
522	40	600 (Medium Wall)	1,681.00
523	40	1000 (Medium Wall)	2,200.00
524	50	500 (Medium Wall)	2,700.00
525	50	1000 (Medium Wall)	3,400.00
526	60	600 (Medium Wall)	3,800.00
527	60	1000 (Medium Wall)	4,500.00
528	80	500 (Medium Wall)	5,000.00
529	80	1000 (Medium Wall)	5,200.00
530	100	500 (Medium Wall)	6,000.00
531	100	1000 (Medium Wall)	6,500.00
532	120	500 (Medium Wall)	8,000.00
533	120	1000 (Medium Wall)	8,500.00
534	150	1000 (Medium Wall)	1,000.00

SMV – A-75 Chromatography Columns, With Socket Glass Stop Cock

Cat. No.	Socket	Dia/Length mm	Price
535	4/23	18x150	900.00
536	19/26	22x300	900.00
537	19/26	22x450	950.00
538	24/29	30x300	950.00
539	24/29	30x450	950.00
540	24/29	30x600	1,000.00
541	29/32	40x600	1,100.00
542	29/32	40x1000	1,300.00
543	34/35	60x500	1,800.00
544	34/35	60x1000	2,200.00
545	34/35	75x1000	2,780.00
546	34/35	80x1000	3,869.00
547	34/35	100x1000	5,987.00

SMV – A-76 Chromatography Columns, With Socket PTFE Stop Cock

Cat. No.	Socket	Dia/Length mm	Price
548	14/23	18x150	580.00
549	19/26	22x300	590.00
550	19/26	22x450	620.00
551	24/29	30x300	760.00
552	24/29	30x450	1,050.00
553	24/29	30x600	1,250.00
554	29/32	40x600	1,300.00
555	29/32	40x1000	1,500.00
556	34/35	60x500	2,100.00
557	34/35	60x1000	2,456.00
558	34/35	75x1000	3,108.00
559	34/35	80x1000	4,069.00
560	34/35	100x1000	6,458.00

SMV – A-77 Chromatography Columns, With Sintered Disc and Stopcock G1 to G4

Cat. No.	Dia	Length mm	Price
561	20	300 (Medium Wall)	1,000.00
562	30	300 (Medium Wall)	1,600.00
563	30	600 (Medium Wall)	1,200.00
564	40	600 (Medium Wall)	1,644.00
565	40	1000 (Medium Wall)	1,681.00
566	50	600 (Medium Wall)	2,200.00
567	50	1000 (Medium Wall)	2,500.00
568	60	600 (Medium Wall)	2,900.00
569	60	1000 (Medium Wall)	3,200.00
570	80	600 (Medium Wall)	3,400.00
571	80	1000 (Medium Wall)	4,950.00
572	100	600 (Medium Wall)	5,210.00
573	100	1000 (Medium Wall)	5,980.00
574	120	600 (Medium Wall)	6,450.00
575	120	1000 (Medium Wall)	8,450.00
576	150	1000 (Medium Wall)	10,950.00

SMV – A-78 Chromatography Columns, With Sintered Disc PTFE Stopcock G1to G4

Cat. No.	Dia	Length mm	Price
577	20	300 (Medium Wall)	1,155.00
578	30	300 (Medium Wall)	1,425.00
579	30	600 (Medium Wall)	1,820.00
580	40	600 (Medium Wall)	1,850.00
581	40	1000 (Medium Wall)	1,855.00
582	50	600 (Medium Wall)	2,350.00
583	50	1000 (Medium Wall)	2,651.00
584	60	600 (Medium Wall)	3,150.00
585	60	1000 (Medium Wall)	3,360.00
586	80	600 (Medium Wall)	3,625.00
587	80	1000 (Medium Wall)	5,269.00
588	100	600 (Medium Wall)	5,368.00
589	100	1000 (Medium Wall)	5,321.00
590	120	600 (Medium Wall)	6,650.00
591	120	1000 (Medium Wall)	8,900.00
592	150	1000 (Medium Wall)	11,680.00

SMV – A-79 Flash Columns Plain with Stopcock (PTFE & S-35 Joint)

Cat. No.	Dia. mm	Length mm	RB Flask	Price
593	15	300	100	1,954.00
594	15	400	100	1,996.00
595	18	450	100	2,127.00
596	20	210	150	2,080.00
597	20	400	150	2,100.00
598	30	300	150	2,117.00
599	30	450	250	2,248.00
600	36	300	250	2,300.00
601	36	450	500	2,353.00
602	40	350	500	2,458.00
603	40	450	500	2,626.00
604	40	600	500	2,626.00
605	45	300	500	2,679.00
606	45	450	500	2,679.00
607	50	400	500	3,700.00
608	50	600	500	3,900.00

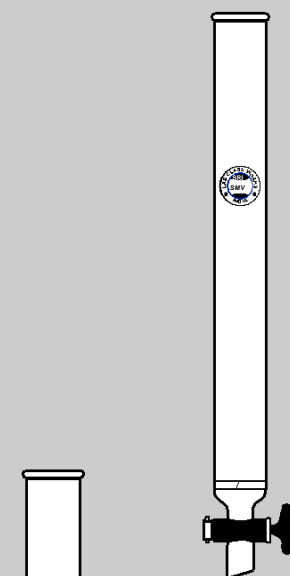

A-77

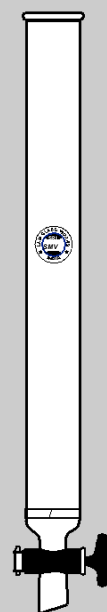

A-78



A-79

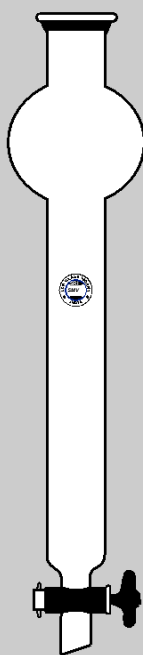

A-80



A-81

SMV – A-80 Flash Columns Plain with P.T.F.E Stopcock S-51 Joint

Cat. No.	Dia. mm	Length mm	RB Flask	Price
609	15	300	100	2,269.00
610	15	400	100	2,311.00
611	18	450	100	2,447.00
612	20	210	150	2,395.00
613	20	400	150	2,458.00
614	30	300	150	2,500.00
615	30	450	250	2,563.00
616	36	300	250	2,615.00
617	36	450	500	2,668.00
618	40	350	500	3,000.00
619	40	450	500	3,200.00
620	40	600	500	3,495.00
621	45	300	500	3,590.00
622	45	450	500	3,600.00
623	50	400	500	4,200.00
624	50	600	500	4,499.00
625	55	450	500	4,499.00
626	55	600	500	4,800.00
627	60	400	500	5,000.00
628	60	650	1000	5,200.00
629	60	800	1000	5,800.00
630	75	650	1000	6,000.00
631	80	500	1000	6,110.00
632	80	650	1000	6,432.00
633	100	650	2000	6,990.00

SMV – A-81 Flash Columns with Sintered Disc G1 to G4 With P.T.F.E Stopcocks S-35 Joint

Cat. No.	Dia. mm	Length mm	RB Flask	Price
634	15	300	100	3,151.00
635	15	400	100	3,800.00
636	16	450	100	3,800.00
637	20	210	150	4,000.00
638	20	400	150	4,000.00
639	30	300	150	4,000.00
640	30	450	250	4,200.00
641	36	300	250	4,200.00
642	36	450	500	4,300.00
643	40	350	500	4,600.00
644	40	500	500	4,700.00
645	42	450	500	4,800.00
646	45	300	500	5,000.00
647	45	450	500	5,455.00
648	50	400	500	5,650.00
649	50	600	500	5,850.00
650	55	450	500	6,129.00
651	55	600	500	6,300.00

SMV – A-82 Flash Columns with Sintered Disc G1 to G4 with P.T.F.E Stopcocks S-51 Joint

Cat. No.	Dia. mm	Length mm	RB Flask	Price
652	15	300	100	3,382.00
653	15	400	100	3,536.00
654	16	450	100	3,536.00
655	20	210	150	3,643.00
656	20	400	150	3,702.00
657	30	300	150	3,731.00
658	30	450	250	4,100.00
659	36	300	250	4,100.00
660	36	450	500	4,200.00
661	40	350	500	4,300.00
662	40	500	500	4,800.00
663	45	300	500	5,000.00
664	45	450	500	5,000.00
665	50	400	500	5,400.00
666	50	600	500	5,500.00
667	55	450	500	5,812.00
668	55	600	500	5,918.00
669	60	400	500	5,712.00
670	60	650	1000	6,100.00
671	60	800	1000	6,125.00
672	75	650	1000	6,458.00
673	80	500	1000	6,612.00
674	80	650	1000	6,701.00

SMV – A-83 Flash Columns with P.T.F.E Stopcocks Ground Joint

Cat. No.	Dia. mm	Length mm	RB Flask	Price
675	15	300	100	2,069.00
676	15	400	100	2,111.00
677	18	450	100	2,247.00
678	20	210	150	2,395.00
679	20	400	150	2,158.00
680	30	300	150	2,200.00
681	30	450	250	2,263.00
682	36	300	250	2,315.00
683	36	450	500	2,334.00
684	40	350	500	2,700.00
685	40	450	500	2,900.00
686	40	600	500	3,195.00
687	45	300	500	3,290.00
688	45	450	500	3,300.00
689	50	400	500	3,900.00
690	50	600	500	4,199.00
691	55	450	500	4,199.00
692	55	600	500	4,500.00
693	60	400	500	7,700.00
694	60	650	1000	4,900.00
695	60	800	1000	5,800.00
696	75	650	1000	5,700.00
697	80	500	1000	5,810.00
698	80	650	1000	6,332.00
699	100	650	2000	6,690.00

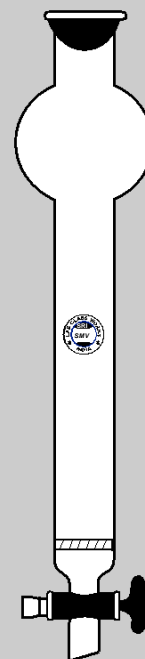

A-82

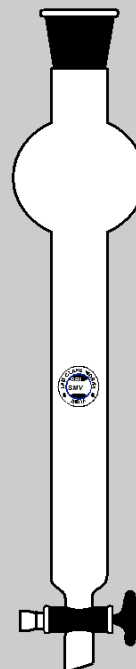

A-83



A-84

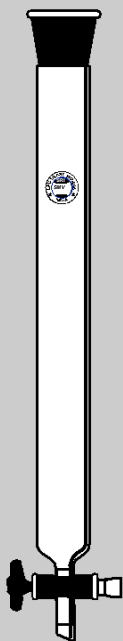

A-85

SMV – A-84 Flash Columns Plain with Glass Stopcocks Ground Joi

Cat. No.	Dia. mm	Length mm	RB Flask	Price
700	15	300	100	1,700.00
701	15	400	100	1,730.00
702	18	450	100	1,730.00
703	20	210	150	1,800.00
704	20	400	150	1,800.00
705	30	300	150	2,050.00
706	30	450	250	2,050.00
707	36	300	250	2,050.00
708	36	450	500	2,368.00
709	40	350	500	2,400.00
710	40	450	500	2,400.00
711	40	600	500	2,400.00
712	45	300	500	2,400.00
713	45	450	500	2,400.00
714	50	400	500	3,600.00
715	50	600	500	3,600.00
716	55	450	500	3,600.00
717	55	600	500	3,600.00
718	60	400	500	4,400.00
719	60	650	1000	4,400.00
720	60	800	1000	4,400.00
721	75	650	1000	6,000.00
722	80	500	1000	6,110.00
723	80	650	1000	6,432.00
724	100	650	2000	6,990.00

SMV – A-85 Column Chromatography Thread Socket Joint, Glass Stopcock

Cat. No.	Dia mm	Length mm	Price
725	15	200 (Medium Wall)	1,400.00
726	20	200 (Medium Wall)	1,400.00
727	20	300 (Medium Wall)	1,600.00
728	20	450 (Medium Wall)	1,600.00
729	25	200 (Medium Wall)	1,600.00
730	25	450 (Medium Wall)	1,600.00
731	30	300 (Medium Wall)	1,600.00
732	30	450 (Medium Wall)	1,600.00
733	30	600 (Medium Wall)	1,600.00
734	40	300 (Medium Wall)	2,200.00
735	40	450 (Medium Wall)	2,200.00
736	40	600 (Medium Wall)	2,600.00
737	40	1000 (Medium Wall)	2,600.00
738	50	450 (Medium Wall)	2,800.00
739	50	600 (Medium Wall)	2,900.00
740	50	1000 (Medium Wall)	2,900.00
741	60	600 (Medium Wall)	3,800.00
742	60	1000 (Medium Wall)	9,900.00

SMV – A-86 Column Flash Chromatography thread Socket Joint, PTFE Stopcock

Cat. No.	Dia mm	Length mm	Price
743	15	200 (Medium Wall)	1,600.00
744	20	200 (Medium Wall)	1,600.00
745	20	300 (Medium Wall)	1,600.00
746	20	450 (Medium Wall)	1,600.00
747	25	200 (Medium Wall)	1,600.00
748	25	450 (Medium Wall)	1,600.00
749	30	300 (Medium Wall)	1,800.00
750	30	450 (Medium Wall)	2,000.00
751	30	600 (Medium Wall)	2,550.00
752	40	300 (Medium Wall)	2,600.00
753	40	450 (Medium Wall)	2,600.00
754	40	600 (Medium Wall)	2,600.00
755	40	1000 (Medium Wall)	2,900.00
756	50	450 (Medium Wall)	3,000.00
757	50	600 (Medium Wall)	3,000.00
758	50	1000 (Medium Wall)	3,500.00
759	60	600 (Medium Wall)	4,000.00
760	60	1000 (Medium Wall)	4,200.00

SMV – A-87 Flow Control Adapter

Cat. No.	Joint	Price
761	24/29	740.00
762	29/32	780.00

SMV – A-88 Flash Column, Regulators with Screw Cock

Cat. No.	Joint	Price
763	S-35	950.00
764	S-51	1,550.00

SMV – A-89 Clamps for Flash Column

Cat. No.	Joint	Price
765	S-35	450.00
766	S-51	750.00

SMV – A-90 Chromatography Columns, With Integral Sinter

Cat. No.	Ht.X Dia. Mm	Approx. Cap.ml	Joint Size	Price
767	10x200	14/23	19/26	330.00
768	10x300	14/23	19/26	350.00
769	10x400	14/23	19/26	390.00
770	18x200	24/29	19/26	440.00
771	18x300	24/29	19/26	481.00
772	18x400	24/29	19/26	512.00
773	30x200	34/35	24/29	675.00
774	30x300	34/35	24/29	780.00
775	30x400	34/35	24/29	802.00



A-86

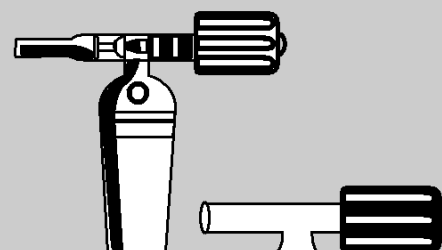

A-87



A-88

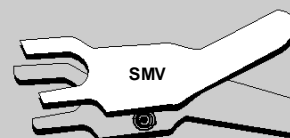

A-89



A-90

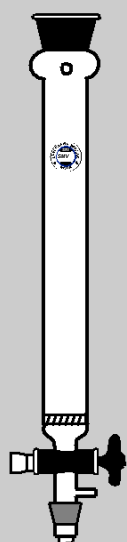

A-91

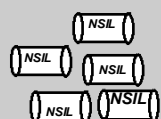

A-93



A-92

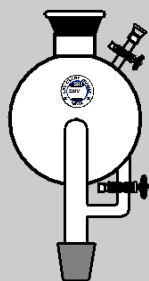

A-94A

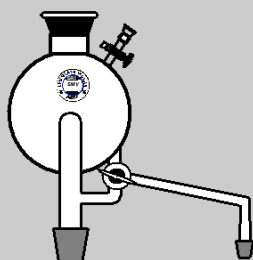

A-94B



A-95

SMV – A-91 Chromatography Columns, With Integral Sinter & Stopcock

Cat. No.	Ht. X Dia. Mm	Approx. Cap.ml	Joint Size	Price
776	10x200	14/23	19/26	560.00
777	10x300	14/23	19/26	605.00
778	10x400	14/23	19/26	659.00
779	18x100	24/29	19/26	690.00
780	18x200	24/29	24/29	720.00
781	18x300	24/29	19/26	790.00
782	30x100	34/35	24/29	1,389.00
783	30x300	34/35	24/29	1,389.00
784	30x400	34/35	24/29	1,490.00

SMV – A-92 Fractionating Columns Plain

Cat. No.	Socket	Cone	Length mm	Price
785	14/23	14/23	100	300.00
786	19/26	19/26	100	350.00
787	19/26	19/26	200	400.00
788	19/26	19/26	300	400.00
789	24/29	24/29	300	400.00
790	24/29	24/29	450	456.00
791	24/29	24/29	600	510.00
792	29/32	29/32	450	500.00
793	29/32	29/32	600	550.00
794	34/35	34/35	450	815.00
795	34/35	34/35	600	1,019.00
796	34/34	34/35	1000	1,350.00
797	55/55	55/55	600	1,690.00

SMV – A-93 Rasching Rings for Packing Kg.

Cat. No.	Dia/mm	Length mm	Price
798	4	4	2,835.00
799	6	6	2,839.00
800	8	8	2,836.00

SMV – A-94 THF Distillation (or) Solvent Reservoir

Cat. No.	Cap ml	Size	Price
801	250	24/29	5,500.00
802	500	24/29	6,000.00
803	1000	24/29	6,500.00
804	2000	24/29	7,500.00

SMV – A-95 Fractionating Columns, Vigreux

Cat. No.	Socket	Cone	Length mm	Price
805	19/26	19/26	100	506.00
806	19/26	19/26	200	650.00
807	19/26	19/26	300	800.00
808	24/29	24/29	100	580.00
809	24/29	24/29	200	690.00
810	24/29	24/29	300	950.00
811	24/29	24/29	450	1,300.00
812	24/29	24/29	600	1,510.00
813	29/32	29/32	300	1,300.00
814	29/32	29/32	450	1,510.00
815	29/32	29/32	600	1,650.00
816	34/35	34/36	300	1,500.00
817	34/35	34/36	450	1,800.00
818	34/35	34/35	600	1,902.00

SMV – A-96 Distilling Head, Claisen- Vigreux (Also available with Sealed Thermometer pack).

Cat. No.	Flask Cone	Cond.Cone	Socket	Price
819	14/23	14/23	14/23	2,003.00
820	19/26	19/26	19/26	2,003.00
821	19/26	19/26	24/29	2,003.00
822	24/29	24/29	24/29	2,184.00
823	29/32	29/32	29/32	2,914.00
824	19/26	19/26	19/26	2,178.00

SMV – A-97 Fractioning Column ,Vacuum -Jacketed, Vigreux

Cat No.	Jacket Length	AllSize	Price
825	360	—	6,024.00

SMV - A-98 Diffusion Cells

Cat No	Cap MI	Price
826	Diffusion Cells Plain, 5ml	1,600.00
827	Diffusion Cells Plain, 10ml	1,800.00
828	Diffusion Cells Plain, 15ml	1,900.00
829	Diffusion Cells Plain ,20ml	2,200.00
830	Diffusion Cells Plain ,25ml	2,600.00
831	Diffusion Cells Plain ,50ml	2,800.00
832	Diffusion Cells Plain 100ml	5,200.00

SMV-A-99 Diffusion Cells Jacketed

Cat No	Cap MI	Price
833	Diffusion Cells Jacketed, 5ml	1,900.00
834	Diffusion Cells Jacketed, 10ml	2,000.00
835	Diffusion Cells Jacketed, 15ml	2,200.00
836	Diffusion Cells Jacketed, 20ml	2,600.00
837	Diffusion Cells Jacketed, 25ml	2,600.00
838	Diffusion Cells Jacketed, 50ml	3,600.00
839	Diffusion Cells Jacketed, 100ml	6,200.00

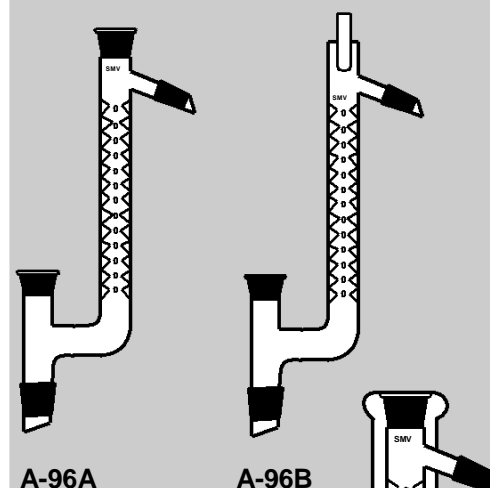

A-96A

A-96B

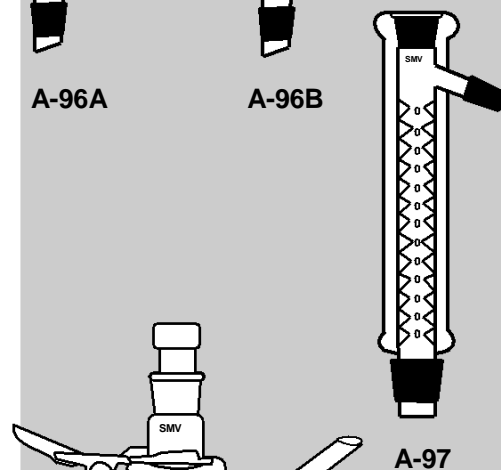

A-97

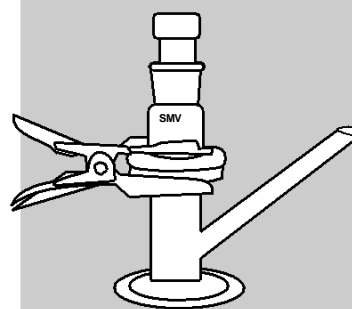

A-98

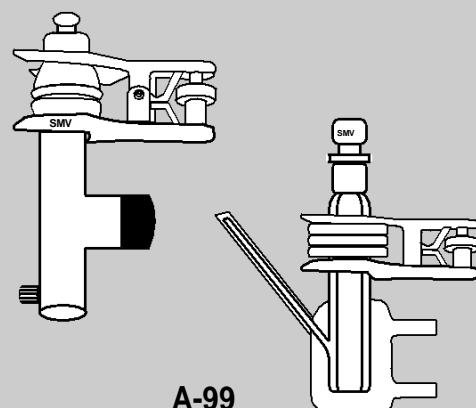

A-99

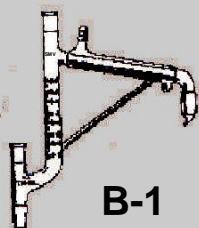

B-1

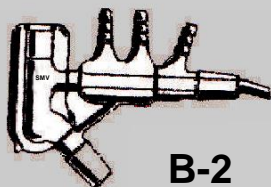

B-2

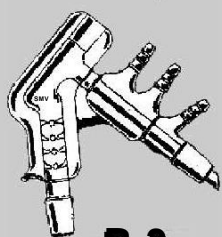

B-3

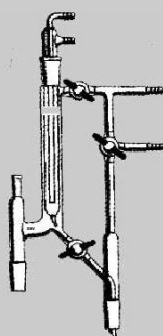

B-4

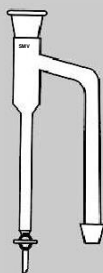

B-5

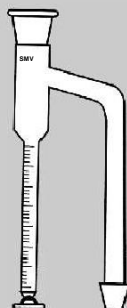

B-6

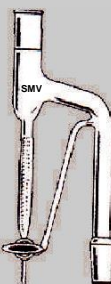

B-7



B-9

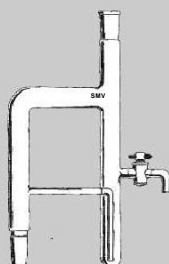

B-8

SMV-B-1 Distilling Head, Claisen – Vigreux

Cat no.	Flask Cone	Cond. Cone	Condenser	Price
840	14/23	14/23	100 mm	2,600.00
841	19/26	19/26	200 mm	2,600.00
842	24/29	19/26	250 mm	2,600.00
843	24/29	24/29	250 mm	2,600.00
844	29/32	39/32	250 mm	2,600.00
845	34/35	24/29	250 mm	2,600.00

SMV-B-2 Distilling Head, Micro Short path, Jacketed.

Cat no.	Flask Joint	TP Seal Joint	Length	Price
846	14/23	14/23	100 mm	5,600.00
847	19/26	19/26	100 mm	5,600.00
848	14/23	14/23	200 mm	5,800.00
849	19/26	19/26	200 mm	5,900.00

SMV-B-3 Distilling Head, Micro Short path, Jacketed & Vigreux

Cat no.	Flask Joint	TP Seal Joint	Length	Price
850	14/23	14/23	100 mm	6,000.00
851	19/26	19/26	100 mm	7,200.00
852	14/23	14/23	200 mm	7,200.00
853	19/26	19/26	200 mm	7,200.00

SMV-B-4 Distilling Head, Standard column & receiver with thermometer joint.

Cat No.	Flask Cone	Receiver Joint	Price
854	24/29	24/29	8,980.00
855	29/32	29/32	9,200.00

SMV – B-5 Dean & Stark Apparatus Plain

Cat. No.	Socket	Cone	Price
856	14/23	14/23	998.00
857	19/26	19/26	998.00
858	24/29	24/29	1,090.00
859	29/32	29/32	1,090.00
860	34/35	34/35	1,390.00

SMV – B-6 Dean & Stark Apparatus Graduated

Cat. No.	Socket	Cone	Capacity	Price
861	14/23	14/23	10 ml	1,600.00
862	19/23	19/23	10 ml	1,600.00
863	24/29	24/29	25 ml	2,100.00
864	24/29	24/29	50 ml	2,400.00
865	24/29	24/29	75 ml	2,400.00

SMV – B-7 Distilling Crank case oil Dilution (Receiver Dean& Starck

Cat No.	Capacity ml	Joint	Price
	Sub division	Size	
866	5.0 x 0.1	24.29	3,200.00

SMV-B-8 Distilling receiver, Dean & Stark Modified (The Layer Separate)

Cat No.	App to. Height x Width	Joint	Price
867	355x240	24/29	5,900.00

SMV-B-9 Distilling Receiver Crank case Oil Dilution

Cat No.	Cap Ml	Joint	Price
868	10	19/26	1,800.00
869	25	24/29	1,950.00

SMV – B-10 Droppers

Cat. No.	Dia mm	Length mm	Price
870	8	175	25.00
871	8	225	30.00

SMV – B-11 Bulb Droppers

Cat. No.	Dia mm	Length mm	Price
872	8	175	40.00
873	8	225	50.00

SMV – B-12 Kjeldahi Flasks, Long Neck

Cat. No.	Cap. MI/Ltr	Socket	Price
874	100	24/29	253.00
875	300	24/29	459.00
876	500	24/29	814.00
877	800	24/29	1,019.00

SMV – B-13 Round Bottom Flasks Single Neck (NSIL)

Cat. No.	Cap. MI/Ltr	Socket	Price
878	5 ml	B-14/23	100.00
879	10 ml	B-14/23	110.00
880	10 ml	B-19/26	110.00
881	25 ml	B-14/23	120.00
882	25 ml	B-19/26	120.00
883	50 ml	B-14/23	140.00
884	50 ml	B-19/26	140.00
885	50 ml	B-24/29	140.00
886	100 ml	B-14/23	180.00
887	100 ml	B-19/26	180.00
888	100 ml	B-24/29	180.00
889	100ml	B-29/32	180.00
890	150 ml	B-19/26	313.00
891	150 ml	B-24/29	313.00
892	250 ml	B-14/23	320.00
893	250 ml	B-19/26	320.00
894	250 ml	B-24/29	320.00
895	250 ml	B-29/32	320.00
896	500 ml	B-19/26	360.00
897	500 ml	B-24/29	360.00
898	500 ml	B-29/32	360.00
899	1 Ltr	B-19/26	470.00
900	1 Ltr	B-24/29	470.00
901	1 Ltr	B-29/32	470.00
902	1 Ltr	B-34/35	470.00
903	2 Ltr	B-24/29	890.00
904	2 Ltr	B-29/32	890.00
905	2 Ltr	B-34/35	890.00
906	3 Ltr	B-24/29	2,750.00
907	3 Ltr	B-29/32	2,750.00
908	3 Ltr	B-34/35	2,750.00
909	5 Ltr	B-24/29	4,300.00
910	5 Ltr	B-29/32	4,300.00
911	5 Ltr	B-34/35	4,300.00
912	10 Ltr	B-34/35	6,000.00
913	10 Ltr	B-55/44	6,000.00
914	20 Ltr	B-34/35	9,900.00
915	20 Ltr	B-55/44	9,900.00

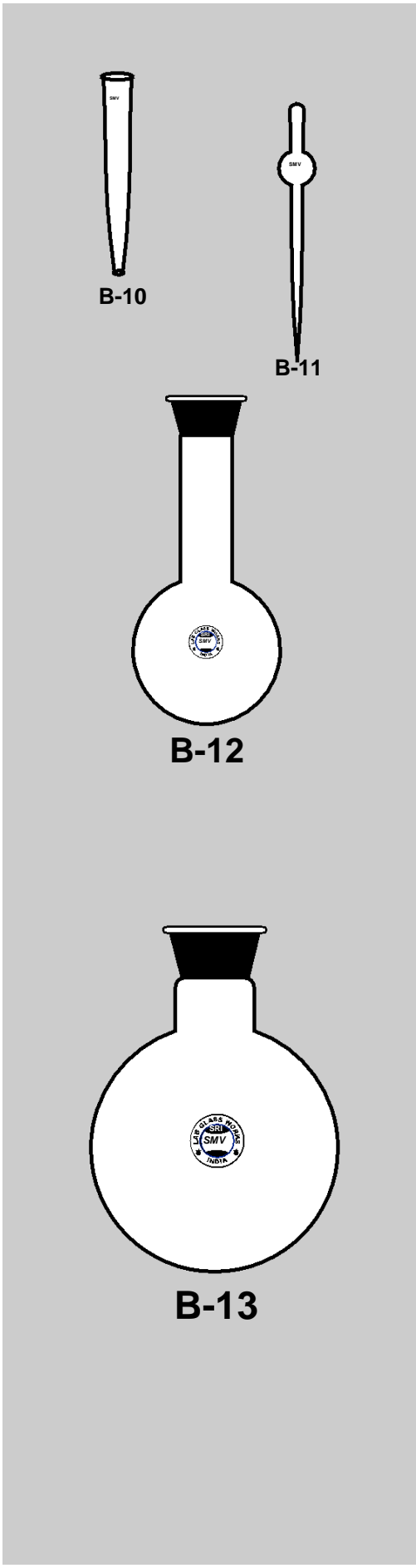



B-14

SMV – B-14 Round Bottom Flasks Two Necks (NSIL)

Cat. No.	Cap. Ml/Ltr	Centre Socket	Side Socket	Price
916	25 ml	B-14/23	14/23	220.00
917	25 ml	B-19/26	14/23	220.00
918	50 ml	B- 19/26	14/23	240.00
919	50 ml	B-19/29	19/26	240.00
920	50 ml	B-24/29	19/26	240.00
921	100 ml	B-19/26	14/23	300.00
922	100 ml	B-19/26	19/26	300.00
923	100 ml	B-24/29	19/26	300.00
924	250 ml	B-19/26	14/23	450.00
925	250 ml	B-19/26	19/26	450.00
926	250 ml	B-24/29	19/26	450.00
927	250ml	B-24/29	24/29	450.00
928	500 ml	B-19/26	19/26	520.00
929	500 ml	B-24/29	19/26	520.00
930	500 ml	B-24/29	24/29	520.00
931	500 ml	B-29/32	24/29	520.00
932	1 Ltr	B-24/29	19/26	730.00
933	1 Ltr	B-24/29	24/29	730.00
934	1 Ltr	B-29/32	24/29	730.00
935	1 Ltr	B-34/35	24/29	730.00
936	2 Ltr	B-24/29	19/26	1,100.00
937	2 Ltr	B-29/32	24/29	1,100.00
938	2 Ltr	B-34/35	24/29	1,100.00
939	3 Ltr	B-24/29	19/26	3,600.00
940	3 Ltr	B-34/35	24/29	3,600.00
941	5 Ltr	B-34/35	24/29	4,900.00
942	5 Ltr	B-34/35	29/32	4,900.00
943	10 Ltr	B-34/35	24/29	8,235.00
944	10 Ltr	B-55/44	34/35	8,235.00
945	20 Ltr	B-34/35	24/29	12,390.00
946	20 Ltr	B-55/44	34/35	12,390.00

SMV – B-15 Round Bottom Flasks, Three Necks (NSIL)

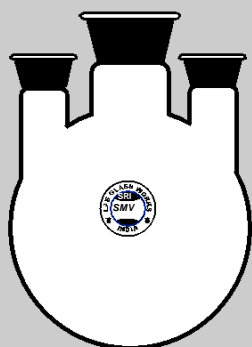

B-15

Cat.No.	Cap.Ml/Ltr	Centre Socket	Side Socket	Price
947	25 ml	B-14/23	14/23	273.00
948	25 ml	B-19/26	14/23	273.00
949	50 ml	B-19/26	14/23	340.00
950	50 ml	B-19/29	19/26	340.00
951	50 ml	B-24/29	19/26	340.00
952	100 ml	B-19/26	14/23	400.00
953	100 ml	B-19/26	19/26	400.00
954	100 ml	B-24/29	19/26	400.00
955	250 ml	B-19/26	14/23	660.00
956	250 ml	B-19/26	19/26	660.00
957	250 ml	B-24/29	19/26	660.00
958	250ml	B-24/29	24/29	660.00
959	500 ml	B-19/26	19/26	850.00
960	500 ml	B-24/29	19/26	850.00
961	500 ml	B-24/29	24/29	850.00
962	500 ml	B-29/32	24/29	850.00
963	1 Ltr	B-24/29	19/26	930.00
964	1 Ltr	B-24/29	24/29	930.00
965	1 Ltr	B-29/32	24/29	930.00
966	1 Ltr	B-34/35	24/29	930.00
967	2 Ltr	B-24/29	19/26	1,400.00
968	2 Ltr	B-29/32	24/29	1,400.00
969	2 Ltr	B-34/35	24/29	1,400.00
970	3 Ltr	B-24/29	19/26	3,250.00
971	3 Ltr	B-34/35	24/29	3,250.00
972	5 Ltr	B-34/35	24/29	5,700.00
973	5 Ltr	B-34/35	29/32	5,700.00
974	10 Ltr	B-34/35	24/29	10,315.00
975	10 Ltr	B-55/44	34/35	10,315.00
976	20 Ltr	B-34/35	24/29	14,470.00
977	20 Ltr	B-55/44	34/35	14,470.00

SMV – B-16 Round Bottom Flasks, Four Necks (NSIL)

Cat.No.	Cap. Ml/Ltr	Centre Socket	Side Socket	Price
978	100 ml	B-19/26	14/23	450.00
979	100 ml	B-19/26	19/26	450.00
980	100 ml	B-24/29	19/26	450.00
981	250 ml	B-19/26	14/23	690.00
982	250 ml	B-19/26	19/26	690.00
983	250 ml	B-24/29	19/26	690.00
984	250 ml	B-24/29	24/29	690.00
985	500 ml	B-19/26	19/26	900.00
986	500 ml	B-24/29	19/26	900.00
987	500 ml	B-24/29	24/29	900.00
988	500 ml	B-29/32	24/29	900.00
989	1 Ltr	B-24/29	19/26	985.00
990	1 Ltr	B-24/29	24/29	985.00
991	1 Ltr	B-29/32	24/29	985.00
992	1 Ltr	B-34/35	24/29	985.00
993	2 Ltr	B-24/29	19/26	1,700.00
994	2 Ltr	B-29/32	24/29	1,700.00
995	2 Ltr	B-34/35	24/29	1,700.00
996	3 Ltr	B-24/29	19/26	4,700.00
997	3 Ltr	B-34/35	24/29	4,700.00
998	5 Ltr	B-34/35	24/29	5,845.00
999	5 Ltr	B-34/35	29/32	5,845.00
1000	10 Ltr	B-34/35	24/29	11,395.00
1001	10 Ltr	B-55/44	34/35	11,395.00
1002	20 Ltr	B-34/35	24/29	14,770.00
1003	20 Ltr	B-55/44	34/35	14,770.00

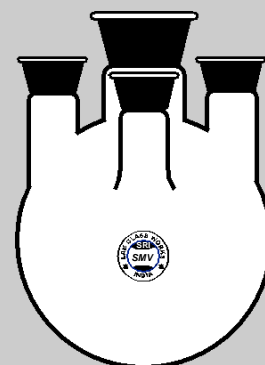

B-16

SMV – B-17 Round Bottom Flasks Single Neck (DURAN)

Cat. No.	Cap. Ml/Ltr	Socket	Price
1004	250 ml	B-14/23	305.00
1005	250 ml	B-19/26	305.00
1006	250 ml	B-24/29	305.00
1007	250 ml	B-29/32	305.00
1008	250 ml	B-34/35	305.00
1009	500 ml	B-19/26	337.00
1010	500 ml	B-24/29	337.00
1011	500 ml	B-29/32	337.00
1012	500 ml	B-34/35	337.00
1013	1 Ltr	B-19/26	448.00
1014	1 Ltr	B-24/29	448.00
1015	1 Ltr	B-29/32	448.00
1016	1 Ltr	B-34/35	448.00
1017	2 Ltr	B-24/29	1,087.00
1018	2 Ltr	B-34/35	1,087.00
1019	2 Ltr	B-29/32	1,087.00
1020	3 Ltr	B-24/29	3,100.00
1021	3 Ltr	B-29/32	3,100.00
1022	3 Ltr	B-34/35	3,100.00
1023	5 Ltr	B-24/29	4,688.00
1024	5 Ltr	B-29/32	4,688.00
1025	5 Ltr	B-34/35	4,688.00
1026	10 Ltr	B-34/35	6,887.00
1027	10 Ltr	B-55/44	6,887.00
1028	20 Ltr	B-34/35	11,307.00
1029	20 Ltr	B-55/44	11,307.00



B-17



B-18

SMV – B-18 Round Bottom Flasks, Two Necks (DURAN)

Cat.No.	Cap. MI/Ltr	Centre Socket	Side Socket	Price
1030	250 ml	B-19/26	14/23	527.00
1031	250 ml	B-19/26	19/26	527.00
1032	250 ml	B-24/29	19/26	527.00
1033	250 ml	B-24/26	24/24	527.00
1034	500 ml	B-19/26	19/26	610.00
1035	500 ml	B-24/29	19/26	610.00
1036	500 ml	B-24/29	24/29	610.00
1037	500 ml	B-29/32	24/29	610.00
1038	1 Ltr	B-24/29	19/26	764.00
1039	1 Ltr	B-24/29	24/29	764.00
1040	1 Ltr	B-29/32	24/29	764.00
1041	1 Ltr	B-34/35	24/29	764.00
1042	2 Ltr	B-24/29	19/26	1,535.00
1043	2 Ltr	B-29/32	24/29	1,535.00
1044	2 Ltr	B-34/35	24/29	1,535.00
1045	3 Ltr	B-24/29	19/26	3,807.00
1046	3 Ltr	B-34/35	24/29	3,807.00
1047	5 Ltr	B-34/35	24/29	5,358.00
1048	5 Ltr	B-34/35	29/32	5,358.00
1049	10 Ltr	B-34/35	24/29	7,564.00
1050	10 Ltr	B-55/44	34/35	7,564.00
1051	20 Ltr	B-34/35	24/29	12,980.00
1052	20 Ltr	B-55/44	34/35	12,980.00

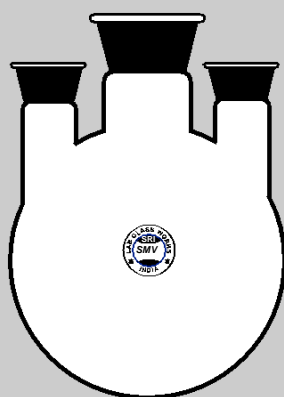

B-19

SMV – B-19 Round Bottom Flasks, Three Necks (DURAN)

Cat.No.	Cap.MI/Ltr	Centre Socket	Side Socket	Price
1053	250 ml	B-19/26	14/23	559.00
1054	250 ml	B-19/26	19/26	559.00
1055	250 ml	B-24/29	19/26	559.00
1056	250 ml	B-24/29	24/29	559.00
1057	500 ml	B-19/26	19/26	987.00
1058	500 ml	B-24/29	19/26	987.00
1059	500 ml	B-24/29	24/29	987.00
1060	500 ml	B-29/32	24/29	987.00
1061	1 Ltr	B-24/29	19/26	1,085.00
1062	1 Ltr	B-24/29	24/29	1,085.00
1063	1 Ltr	B-29/32	24/29	1,085.00
1064	1 Ltr	B-34/35	24/29	1,085.00
1065	2 Ltr	B-24/29	19/26	2,069.00
1066	2 Ltr	B-29/32	24/29	2,069.00
1067	2 Ltr	B-34/35	24/29	2,069.00
1068	3 Ltr	B-24/29	19/26	4,610.00
1069	3 Ltr	B-34/35	24/29	4,610.00
1070	5 Ltr	B-34/35	24/29	6,350.00
1071	5 Ltr	B-34/35	29/32	6,350.00
1072	10 Ltr	B-34/35	24/29	10,980.00
1073	10 Ltr	B-55/44	34/35	10,980.00
1074	20 Ltr	B-34/35	24/29	15,601.00
1075	20 Ltr	B-55/44	34/35	15,601.00

SMV – B-20 Round Bottom Flasks, Four Necks (DURAN)

Cat.No.	Cap.Ml/Ltr	Centre Socket	Side Socket	Price
1076A	100 ml	B-24/29	19/26	450.00
1076	250 ml	B-19/26	14/23	990.00
1077	250 ml	B-19/26	19/26	990.00
1078	250 ml	B-24/29	19/26	990.00
1079	250 ml	B-24/29	24/29	990.00
1080	500 ml	B-19/26	19/26	1,258.00
1081	500 ml	B-24/29	19/26	1,258.00
1082	500 ml	B-24/29	24/29	1,258.00
1083	500 ml	B-29/32	24/29	1,258.00
1084	1 Ltr	B-24/29	19/26	1,369.00
1085	1 Ltr	B-24/29	24/29	1,369.00
1086	1 Ltr	B-29/32	24/29	1,369.00
1087	1 Ltr	B-34/35	24/29	1,304.00
1088	2 Ltr	B-24/29	19/26	2,563.00
1089	2 Ltr	B-29/32	24/29	2,563.00
1090	2 Ltr	B-34/35	24/29	2,563.00
1091	3 Ltr	B-24/29	19/26	5,655.00
1092	3 Ltr	B-34/35	24/29	5,655.00
1093	5 Ltr	B-34/35	24/29	6,700.00
1094	5 Ltr	B-34/35	29/32	6,700.00
1095	10 Ltr	B-34/35	24/29	12,324.00
1096	10 Ltr	B-55/44	34/35	12,324.00
1097	20 Ltr	B-34/35	24/29	16,104.00
1098	20 Ltr	B-55/44	34/35	16,104.00

SMV – B-21 Round Bottom Flasks, 4 Necks (AMBER DURAN)

Cat.No.	Cap.Ml/Ltr	Centre Socket	Side Socket	Price
1099	250 ml	B-24/29	19/26	P.O.R
1100	250 ml	B-24/29	24/29	P.O.R
1101	500 ml	B-24/29	19/26	P.O.R
1102	500 ml	B-24/29	24/29	P.O.R
1103	1 Ltr	B-24/29	19/26	P.O.R
1104	1 Ltr	B-24/29	24/29	P.O.R
1105	1 Ltr	B-34/35	24/29	P.O.R
1106	2 Ltr	B-24/29	19/26	P.O.R
1107	2 Ltr	B-29/32	24/29	P.O.R
1108	2 Ltr	B-34/35	24/29	P.O.R
1109	3 Ltr	B-34/35	24/29	P.O.R
1110	5 Ltr	B-34/35	24/29	P.O.R
1111	10 Ltr	B-34/35	24/29	P.O.R
1112	10 Ltr	B-55/44	34/35	P.O.R
1113	20 Ltr	B-34/35	24/29	P.O.R
1114	20 Ltr	B-55/44	34/35	P.O.R

SMV-B-22 Synthesis Flasks four & Three neck

Cat No.	Cap. Ml	Centre-Socket	Side-Sockets	Price
1115	100	24/29	19/26	P.O.R
1116	250	24/29	19/26	P.O.R
1117	250	24/29	24/29	P.O.R
1118	500	24/29	19/26	P.O.R
1119	500	24/29	24/29	P.O.R
1120	1000	24/29	19/26	P.O.R
1121	1000	24/29	24/29	P.O.R
1122	2000	34/29	24/29	P.O.R
1123	3000	34/29	24/29	P.O.R
1124	5000	34/29	24/29	P.O.R



B-20



B-21

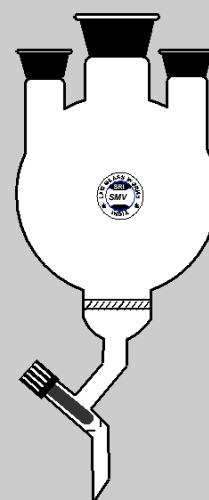

B-22

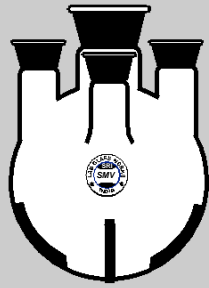

B-23

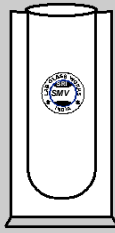

B-24

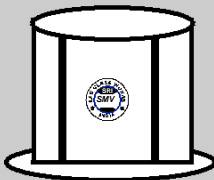

B-25

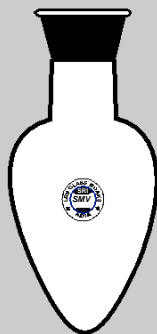

B-26



B-27



B-28

SMV – B-23 Morton Flask four neck

Cat No.	Cap. MI	Centre-Socket	Side-Sockets	Price
1125	100	24/29	19/26	P.O.R
1126	250	24/29	19/26	P.O.R
1127	250	24/29	24/29	P.O.R
1128	500	24/29	19/26	P.O.R
1129	500	24/29	24/29	P.O.R
1130	1000	24/29	19/26	P.O.R
1131	1000	24/29	24/29	P.O.R
1132	2000	34/29	24/29	P.O.R
1133	3000	34/29	24/29	P.O.R
1134	5000	34/29	24/29	P.O.R

SMV – B-24 Flask Dewar (Silvered, Vacuum) With Aluminum Casing

Cat. No.	Capacity	Dia. mm	Length mm	Price
1135	250	50	160	P.O.R
1136	500	65	200	P.O.R
1137	750	75	200	P.O.R
1138	1000	80	300	P.O.R
1139	2000	95	175	P.O.R
1140	3000	100	500	P.O.R

SMV – B-25 Flask Dewar (Silvered, Vacuum) With Aluminum Casing Short Length

Cat. No.	Capacity	Price
1141	250	P.O.R
1142	500	P.O.R
1143	750	P.O.R
1144	1000	P.O.R
1145	2000	P.O.R
1146	3000	P.O.R

SMV – B-26 Pear Shaped Flasks, Single Neck

Cat. No.	Cap.ml	Socket	Price
1147	5	10/19	142.00
1148	5	14/23	142.00
1149	10	19/26	142.00
1150	10	14/23	142.00
1151	10	19/26	142.00
1152	25	10/19	142.00
1153	25	14/23	142.00
1154	25	19/26	142.00
1155	50	14/23	203.00
1156	50	19/26	203.00
1157	100	14/23	268.00
1158	100	19/26	268.00
1159	100	24/29	268.00

SMV – B-27 Pear Shaped Flasks, Two Necks, Centre neck and one Angled Side Neck

Cat.No.	Cap.MI/Ltr	Centre Socket	Side Socket	Price
1160	50	14/23	14/23	299.00

SMV - B-28 Pear Shaped Flasks, Distillation

Cat No.	Cap.ml	Socket	Cone	Price
1161	50	14/23	14/23	299.00
1162	10	14/23	14/23	266.00
1163	25	14/23	14/23	266.00
1164	50	14/23	14/23	292.00

SMV-B-29 Pear Shaped Flasks, Claisen

Cat No.	Cap.ml	Socket	Cone	Price
1166	10	14/23	14/23	412.00
1167	25	10/19	10/19	412.00
1168	25	14/23	14/23	412.00
1169	50	14/23	14/23	466.00
1170	100	14/23	14/23	513.00

SMV – B-30 Kjeldhal Flasks, Round Bottom, Long Neck

Cat. No.	Cap.ml	Price
1171	10	73.00
1172	30	107.00
1173	100	163.00

SMV – B-31 Distillation Flasks

Cat. No.	Cap.ml	Price
1174	10	71.00
1175	25	98.00
1176	50	126.00
1177	100	178.00

SMV – B-32 Filter Funnels

Cat. No.	Dia.mm	Price
1178	35	62.00
1179	50	120.00
1180	65	140.00
1181	75	150.00
1182	100	190.00

SMV – B-33 Funnels Powder Glass

Cat. No.	Dia.mm	Joint	Price
1183	75	19/26	500.00
1184	75	24/29	500.00
1185	100	19/26	600.00
1186	100	24/29	600.00

SMV -B-34 Filter Pump University College Pattern

Cat No.	Description	Price
1187	University College Pattern	1400.00

SMV - Nsil-B-35 Separating Funnels, Cylindrical

Cat No.	Cap.ml	Price
1188	25	523.00
1189	50	523.00
1190	100	743.00
1191	250	900.00
1192	500	1,345.00
1193	1000	1,830.00
1194	2000	4,000.00

SMV - B-36 Separating Funnels, Cylindrical PTFE Stopcock

Cat No.	Cap.ml	Price
1195	25	877.00
1196	50	877.00
1197	100	1,083.00
1198	250	1,218.00
1199	500	1,227.00
1200	1000	2,337.00
1201	2000	4,825.00



B-29



B-30

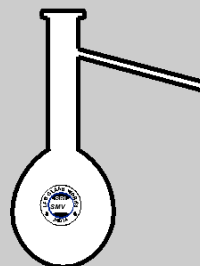

B-31

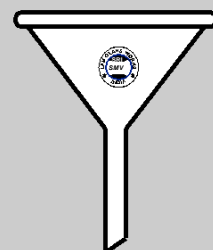

B-32

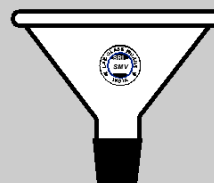

B-33

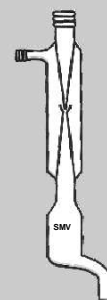

B-34

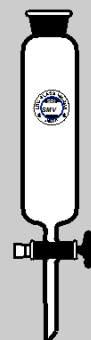

B-35

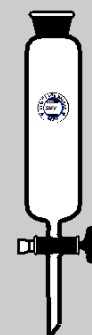

B-36



B-37



B-38



B-39

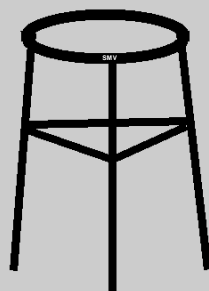

B- 40, 41



B-42

SMV - B-37 Separating Funnels, Spherical Glass Stopcocks

Cat No.	Cap.ml	Price
1202	25	500.00
1203	50	500.00
1204	60	750.00
1205	100	780.00
1206	125	780.00
1207	250	875.00
1208	500	1,170.00
1209	1000	1,500.00
1210	2000	2,800.00
1211	3000	3,800.00
1212	5000	6,600.00
1213	10 ltr	11,300.00

SMV - B-38 Separating Funnels, Spherical With PTFE Plug,

Cat No.	Cap.ml	Price
1214	25	937.00
1215	50	937.00
1216	60	937.00
1217	100	1,062.00
1218	125	1,062.00
1219	250	1,125.00
1220	500	1,562.00
1221	1000	1,750.00
1222	2000	2,750.00
1223	5000	7,200.00

SMV - B-39 Separating Funnels 3/neck Spherical

Cat. No.	Cap.M	Joint	Price
1224	2000 ml	C-34-S-24	3,400.00
1225	3000 ml	C-34-S-24	4,800.00
1226	5000 ml	C-34-S-24	6,600.00
1227	10000 ml	C-34-S-24	12,000.00
1228	20000 ml	C-34-S-24	18,000.00

SMV -B-40 Separating Funnel Stands MS

Cat No.	Capacity ml	Price
1229	5000 ml	P.O.R
1230	10000 ml	P.O.R
1231	20000 ml	P.O.R

SMV - B-41 Separating Funnel Stands S.S

Cat No.	Capacity ml	Price
1232	5000 ml	P.O.R
1233	10000 ml	P.O.R
1234	20000 ml	P.O.R

SMV-B-42 Separating Funnels, Conical Glass Stopcock

Cat No.	Cap. Ml	Price
1235	25	540.00
1236	50	540.00
1237	60	750.00
1238	100	780.00
1239	125	780.00
1240	250	875.00
1241	500	1,170.00
1242	1000	1,500.00
1243	2000	2,800.00

SMV-B-43 Separating Funnel, With PTFE Plug, Conical

Cat no.	Cap. ml	Price
1244	25	710.00
1245	50	710.00
1246	60	710.00
1247	100	840.00
1248	125	877.00
1249	250	900.00
1250	500	1,400.00
1251	1000	1,800.00
1252	2000	3,300.00

SMV-B-44 Dropping Funnel, Cylindrical Glass Stopcock

Cat No.	Cap. ml	Socket	Cone	Price
1253	25	14/23	14/23	500.00
1254	50	14/23	14/23	652.00
1255	100	14/23	14/23	756.00
1256	100	19/26	19/26	756.00
1257	250	19/26	19/26	881.00
1258	500	24/29	19/26	1,299.00
1259	1000	24/29	24/29	1,680.00

SMV - B-45 Dropping Funnel, Spherical, Glass Stopcock

Cat No.	Cap. ml	Socket	Cone	Price
1260	25	14/23	14/23	587.00
1261	50	14/23	14/23	587.00
1262	50	19/26	19/26	587.00
1263	100	14/23	14/23	678.00
1264	100	19/26	19/26	678.00
1265	250	24/29	24/29	785.00
1266	250	19/26	19/26	785.00
1267	500	19/26	19/26	1,103.00
1268	500	24/29	24/29	1,103.00
1269	1000	19/26	19/26	1,580.00
1270	1000	24/29	24/29	1,580.00

SMV-B-46 Pressure Equalizing Funnel, Cylindrical with Graduations

Cat No.	Cap. ml	Socket	Cone	Price
1271	25	19/26	19/26	1,100.00
1272	50	19/26	19/26	1,400.00
1273	100	19/26	19/26	2,200.00
1274	100	24/29	24/29	2,200.00
1275	250	19/26	19/26	2,600.00
1276	250	24/29	24/29	2,600.00
1277	500	24/29	24/29	5,500.00
1278	1 ltr	24/29	24/29	6,500.00



B-43



B-44



B-45

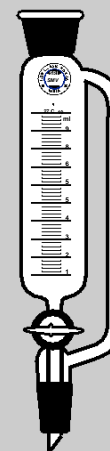

B-46

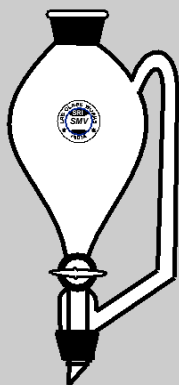

B-47

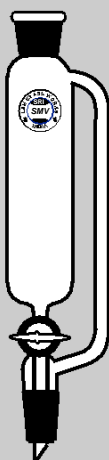

B-48

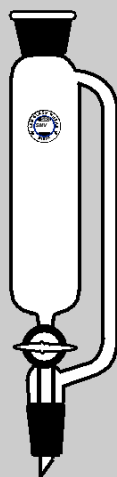

B-49

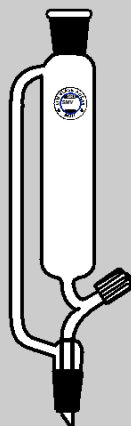

B-50

SMV-B-47 Pressure Equalizing Funnels, Spherical Glass stopcock

Cat No.	Cap. MI	Socket	Cone	Price
1279	25	14/23	14/23	550.00
1280	50	19/26	19/26	650.00
1281	100	19/26	19/26	812.00
1282	100	24/29	19/26	812.00
1283	100	24/29	24/29	812.00
1284	100	29/32	29/32	812.00
1285	250	24/29	19/26	1,208.00
1286	250	24/29	24/29	1,208.00
1287	250	29/32	29/32	1,208.00
1288	500	19/26	19/26	1,801.00
1289	500	24/29	24/29	1,801.00

SMV-B-48 Pressure Equalizing Funnels, Cylindrical PTFE Stopcock

Cat No.	Cap. MI	Socket	Cone	Price
1290	100	19/26	19/26	1,210.00
1291	100	24/29	19/26	1,210.00
1292	100	24/29	24/29	1,210.00
1293	100	29/32	29/32	1,210.00
1294	250	19/26	19/26	1,899.00
1295	250	24/29	24/29	1,899.00
1296	500	19/26	19/26	2,400.00
1297	500	24/29	24/29	2,400.00

SMV-B-49 Pressure Equalizing Funnels, Cylindrical Glass Stopcock

Cat No.	Cap. MI	Socket	Cone	Price
1298	25	14/23	14/23	850.00
1299	50	19/26	19/26	950.00
1300	100	14/23	14/23	1,090.00
1301	100	19/26	19/26	1,090.00
1302	100	24/29	19/26	1,090.00
1303	250	19/26	19/26	1,400.00
1304	250	24/29	19/26	1,400.00
1305	250	24/29	24/29	1,400.00
1306	500	24/29	19/26	2,100.00
1307	500	24/29	24/29	2,100.00
1308	500	24/29	29/32	2,100.00
1309	1000	24/29	24/29	3,062.00
1310	2000	34/35	34/35	5,062.00

SMV-B-50 Pressure Equalizing Funnels, Cylindrical Screw Cock

Cat No.	Cap. MI	Socket	Cone	Price
1311	25	14/23	14/23	980.00
1312	50	19/26	19/26	980.00
1313	100	19/26	19/26	1,010.00
1314	100	24/29	24/29	1,010.00
1315	250	19/26	19/26	1,499.00
1316	250	24/29	24/29	1,499.00

SMV-B-51 Pressure Equalizing Funnels, Jacketed Cylindrical Glass Stopcock

Cat No.	Cap. MI	Socket	Cone	Price
1317	25	14/23	14/23	1,400.00
1318	50	19/26	19/26	1,800.00
1319	100	14/23	14/23	3,800.00
1320	100	19/26	19/26	3,800.00
1321	250	19/26	19/26	5,800.00
1322	250	24/29	19/26	5,800.00
1323	250	24/29	24/29	5,800.00
1324	500	24/29	19/26	8,800.00
1325	500	24/29	24/29	8,800.00
1326	500	24/29	29/32	8,800.00
1327	1000	24/29	24/29	9,000.00
1328	2000	34/35	34/35	9,000.00

SMV-B-52 Pressure Equalizing Funnels Spherical (PTFE Stop Cock)

Cat No.	Cap. MI	Socket	Cone	Price
1329	50	19/26	19/26	750.00
1330	100	19/26	19/26	1,250.00
1331	100	24/26	24/26	1,250.00
1332	250	24/26	24/29	1,450.00
1333	250	19/26	19/26	1,450.00
1334	500	24/26	24/29	2,200.00

SMV-B-53 Buchner Filters (Glass with Sintered)

Cat No.	Cap.ml	Disc/Dia mm	Por	Price
1335	35	30	1	405.00
1336	35	30	2	405.00
1337	35	30	3	405.00
1338	35	30	4	405.00
1339	80	40	1	775.00
1340	80	40	2	775.00
1341	80	40	3	775.00
1342	80	40	4	775.00
1343	200	65	1	1,225.00
1344	200	65	2	1,225.00
1345	200	65	3	1,225.00
1346	200	65	4	1,225.00
1347	500	90	1	2,848.00
1348	500	90	2	2,848.00
1349	500	90	3	2,848.00
1350	500	90	4	2,848.00
1351	1000	120	1	8,545.00
1352	1000	120	2	8,545.00
1353	1000	120	3	8,545.00
1354	1000	120	4	8,545.00
1355	1500	120	1	8,500.00
1356	1500	120	2	8,500.00
1357	1500	120	3	8,500.00
1358	1500	120	4	8,500.00
1359	2000	65	1	13,500.00
1360	2000	65	2	13,500.00
1361	2000	65	3	13,500.00
1362	2000	65	4	13,500.00

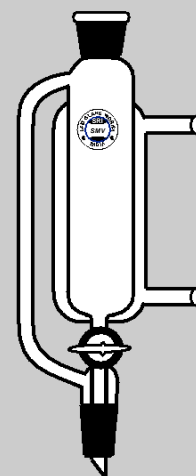

B-51

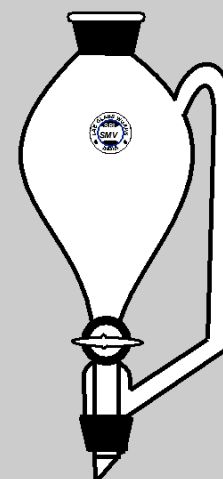

B-52

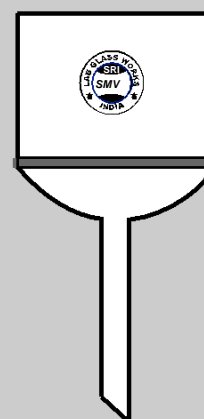

B-53

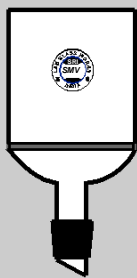

B-54

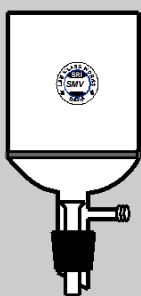

B-55

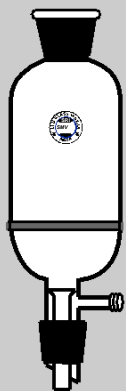

B-56



B-57

SMV -B-54 Buchner Filter, Cone

Cat No.	Cone	Cap. ml	Disc/Dia mm	Por	Price
1363	14/23	100	65	1	1,142.00
1364	19/23	200	65	2	1,842.00
1365	24/29	200	65	3	1,842.00
1366	29/32	200	65	4	1,842.00
1367	14/23	500	65	1	3,281.00
1368	19/23	500	65	2	3,281.00
1369	24/29	500	65	3	3,281.00
1370	29/32	500	65	4	3,281.00

SMV-B-55 Buchner Filter, With Vacuum Connection

Cat No.	Cone	Cap. ml	Disc/Dia mm	Por	Price
1371	14/23	25	30	1 to 4	P.O.R
1372	14/23	50	30	1 to 4	P.O.R
1373	14/23	100	65	1 to 4	P.O.R
1374	19/23	200	65	1 to 4	P.O.R
1375	24/29	200	65	1 to 4	P.O.R
1376	29/32	200	65	1 to 4	P.O.R
1377	19/26	500	90	1 to 4	P.O.R
1378	24/29	500	90	1 to 4	P.O.R
1379	29/32	500	90	1 to 4	P.O.R
1380	34/35	500	90	1 to 4	P.O.R

SMV-B-56 Buchner Filter, Vacuum Connection With Ground Joint

Cat No.	Cone	Cap. ml	Disc/Dia mm	Por	Price
1381	14/23	25	30	1 to 4	P.O.R
1382	14/23	50	30	1 to 4	P.O.R
1383	14/23	100	65	1 to 4	P.O.R
1384	19/23	200	65	1 to 4	P.O.R
1385	24/29	200	65	1 to 4	P.O.R
1386	29/32	200	65	1 to 4	P.O.R
1387	19/26	500	90	1 to 4	P.O.R
1388	24/29	500	90	1 to 4	P.O.R
1389	29/32	500	90	1 to 4	P.O.R
1390	34/35	500	90	1 to 4	P.O.R
1391	34/35	1000	120	1 to 4	P.O.R

SMV-B-57 Buchner Filters Jacketed with Vacuum Connections, Taper Joint

Cat No.	Cap.ml	Cone	Por	Price
1392	35	19/26	1,2,3,4	P.O.R
1393	80	19/26	1,2,3,4	P.O.R
1394	80	24/29	1,2,3,4	P.O.R
1395	200	19/26	1,2,3,4	P.O.R
1396	200	24/29	1,2,3,4	P.O.R
1397	500	24/29	1,2,3,4	P.O.R

SMV-B-58 Buchner filters jacketed with Vacuum Connection, Cone & Socket

Cat No.	Cap.ml	Cone	Por	Price
1398	50	19/26	1,2,3,4	3,500.00
1399	100	19/26	1,2,3,4	5,500.00
1400	100	24/29	1,2,3,4	5,500.00
1401	200	19/26	1,2,3,4	7,500.00
1402	200	24/29	1,2,3,4	7,500.00
1403	500	24/29	1,2,3,4	9,500.00

SMV-B-59 Stirring rod (Glass Rods)

Cat No.	Cap.ml	Disc/Dia mm	Price
1404	6	300	116.00
1405	8	400	200.00
1406	8	450	200.00
1407	8	600	300.00
1408	10	450	300.00
1409	10	500	300.00
1410	10	600	320.00
1411	10	750	350.00
1412	12	750	400.00

SMV-B-60 Stirring rod (Glass Rods) With Teflon Blade

Cat No.	Size	Price
1413	B24 50mm blade to suit for 100 ml, 450 mm	571.00
1414	B24 50mm blade to suit for 250 ml, 450 mm	610.00
1415	B24 50mm blade to suit for 500 ml, 450 mm	610.00
1416	B24 75mm blade to suit for 1000 ml, 8x450 mm	610.00
1417	B34 80mm blade to suit for 2000 ml, 8x450 mm	710.00
1418	B24 90mm blade to suit for 2000 ml, 8x450 mm	710.00
1419	B34 90mm blade to suit for 2000 ml, 8x450 mm	710.00
1420	B34 110mm blade to suit for 3000 ml, 10x450 mm	950.00
1421	B34 125mm blade to suit for 5000 ml, 10x450 mm	950.00
1422	B34 150mm blade to suit for 5000 ml, 10x450 mm	950.00
1423	B34 160mm blade to suit for 10000 ml, 10x600 mm	1,300.00
1424	B34 185mm blade to suit for 20000 ml, 10x750 mm	1,400.00

SMV-B-61 Stoppers, B-SIZE (Hollow)

Cat No.	Cone	Price
1425	10/19	40.00
1426	14/23	80.00
1427	19/26	90.00
1428	24/29	110.00
1429	29/32	120.00
1430	34/35	200.00
1431	40/38	208.00
1432	45/40	225.00
1433	50/42	234.00
1434	55/44	267.00

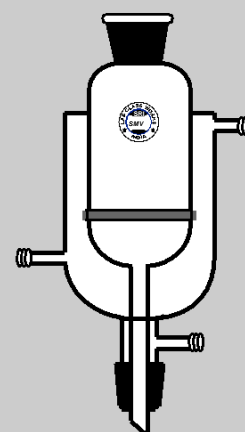

B-58



B-59

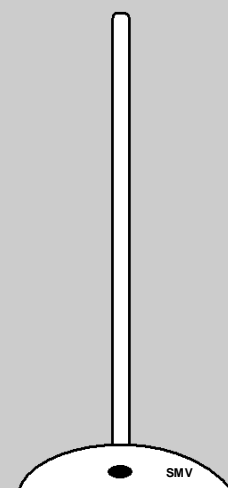

B-60

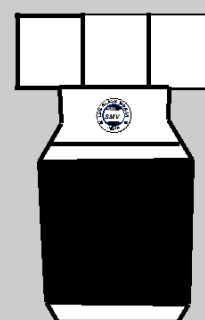

B-61



B-62



B-63



B-64



B-65

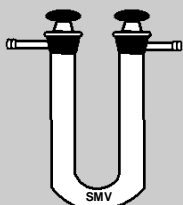

B-66



B-67

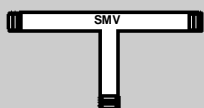

B-68

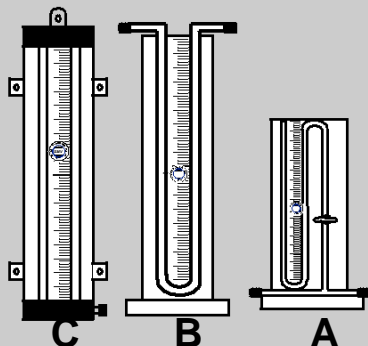

B-69

SMV-B-62 Stoppers, (Solid)

Cat No.	Cone	Price
1435	14/23	148.00
1436	19/26	160.00
1437	24/29	242.00
1438	29/32	290.00
1439	34/35	390.00

SMV-B-63 Stoppers for Volumetric Flask

Cat No.	Cone	Price
1440	10/19	40.00
1441	14/23	50.00
1442	19/26	60.00
1443	24/29	70.00
1444	29/32	120.00
1444a	34/35	290.00

SMV-B-64 Stoppers PP

Cat No.	Size	Price
1445	B-14	100.00
1446	B-19	120.00
1447	B-24	130.00
1448	B-29	150.00
1449	B-34	230.00

SMV-B-65 Teflon Stoppers

Cat No.	Size	Price
1450	B-14	400.00
1451	B-19	450.00
1452	B-24	460.00
1453	B-29	490.00
1454	B-34	697.00

SMV - B-66 Calcium Chloride Tubes, U-Form with Side Tube & Stopper

Cat No.	Length X Dia mm	Joint	Price
1455	100x14	14/23	373.00
1456	125x16	19/26	400.00
1457	150x18	24/29	488.00

SMV-B-67 Calcium Chloride Cylinders

Cat No.	Length X Dia mm	Joint	Price
1458	250x40	34/35	1,508.00
1459	300x40	34/35	1,548.00

SMV-B-68 Connection Tubes T- Shape

Cat No.	Arm Length x Dia mm	Price
1460	40x6	200.00
1461	50x8	200.00
1462	60x10	200.00
1463	80x12	200.00

SMV-B-69 Manometer U – Tube Bennett model

Cat No.	Arm Length x Dia mm	Price
1464 A	10-0-10 cms Bennett model	4,500.00
1465 B	One meter length with Aluminum body	5,500.00
1466 C	One meter length on Wooden Stand	6,600.00

SMV-B-70 Vacuum Traps (Glass)

Cat No.	Cap.ml	Price
1467	25	288.00
1468	50	425.00
1469	100	375.00
1470	250	700.00
1471	500	780.00
1472	1000	862.00

SMV-B-71 Ammonia Trap

Cat No.	Cap.ml	Joint	Price
1473	250	24/29	3,394.00
1474	500	24/29	4,129.00
1475	1000	29/32	6,998.00
1476	2000	34/35	9,321.00

SMV-B-72 Dry Ice Condenser (Dewar Trap)

Bottom and an outer joint of the same style extending in an upward direction
For the side of jacket near the top the inside diameter of flask is approximately 40 mm and the inside height is approximately 150 mm.

Cat No.	Cap.Ml	Cone	Price
1477	100	19/26	4,600.00
1478	250	24/29	5,600.00
1479	500	29/32	6,600.00
1480	1 Ltr	29/32	7,600.00

SMV-B-73 Dry Condenser (Vacuum Trap)

Designed to remove relatively large volumes of solvent can be used with Rotary evaporators. Inner cylinder is charged with dry ice/alcohol or Liquid nitrogen. Lower reservoir has a PTFE valve to remove condensate.

Cat No.	Cap.Ml	Price
1481	250 ml	6,500.00
1482	500 ml	6,800.00
1483	1 Ltr	7,100.00

SMV - B-74 Buchi Flask B29

Cat No.	Cap. MI	Joint	Price
1484	50	B 32	350.00
1485	100	B 32	400.00
1486	250	B 32	650.00
1487	500	B 32	1,200.00
1488	1000	B 32	1,600.00
1489	2000	B 32	2,400.00
1490	3000	B 32	5,413.00

SMV - B-75 Buchi Flask B29 Amber

Cat No.	Cap. MI	Joint	Price
1491	50	B 32	P.O.R.
1492	100	B 32	P.O.R.
1493	250	B 32	P.O.R.
1494	500	B 32	P.O.R.
1495	1000	B 32	P.O.R.
1496	2000	B 32	P.O.R.
1497	3000	B 32	P.O.R.

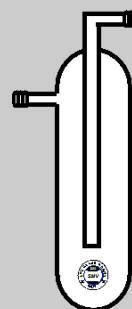
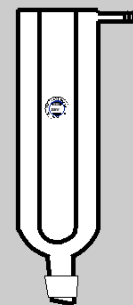
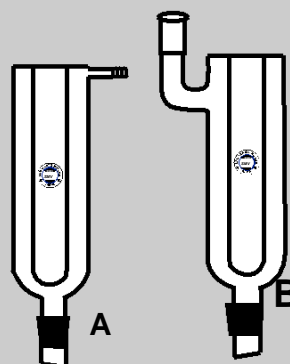
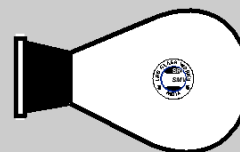
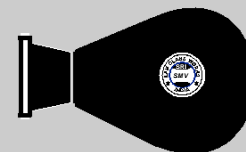
**B-70****B-71****B-72****B-73****B-74****B-75**

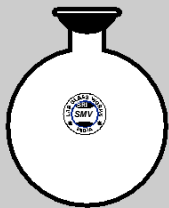

B-76

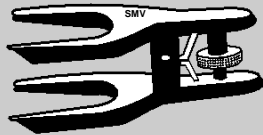

B-77

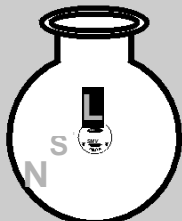

B-82

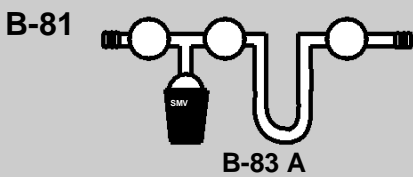

B-81

B-83 A

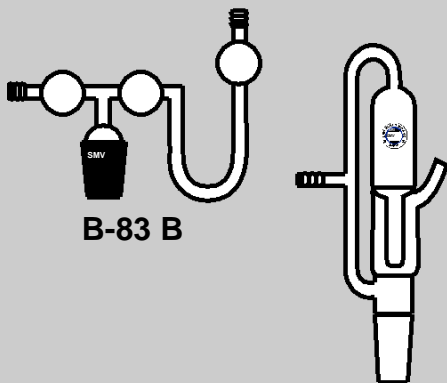

B-83 B

B-84

SMV - B-76 Buchi Receiving Flask S35

Cat No.	Cap. Ml	Joint	Price
1498	250 ml	S35	850.00
1499	500 ml	S35	1,350.00
1500	1000 ml	S35	1,500.00

SMV - B-77 Buchi Clamps SS

Cat No.	Joint	Price
1501	S-29	1,400.00
1502	S-35	1,700.00

SMV - B-78

Cat No.	Price
1503	6,000.00

SMV - B-79

Cat No.	Price
1504	18,000.00

SMV - B-80

Cat No.	Price
1505	1,000.00

SMV - B-81

Cat No.	Price
1506	5,200.00

SMV - B-82 Buchi Evaporating Flask Flange type

Cat No.	Cap. Ml	Price
1507	5000 ml	10,200.00
1508	10000 ml	21,000.00
1509	20000 ml	30,200.00

SMV - B-83 Nitrogen Bubblers

Cat No.	Size	Price
1510	B 14	700.00
1511	B 19	700.00
1512	B 24	700.00
1513	B 29	700.00

SMV - B-84 Bubblers, Nitrogen Bubblers

Cat No.	Cone.Joint	Price
1514	14	900.00
1515	19	958.00
1516	24	1,118.00
1517	29	1,118.00

SMV -B-85 Mini gas Bubblers

Cat No.	Size	Price
1518	40x15 mm	850.00

SMV -B-86 "U" tube Cone bubblers (N2)

Cat No.	Cone. Joint	Price
1519	14/23	500.00
1520	19/26	500.00
1521	24/29	500.00
1522	29/32	500.00
1523	34/35	500.00

SMV-B-87 "U" tube cone bubblers (N2) 30 ml

Cat No.	Cone. Joint	Price
1524	14/23	493.00
1525	19/26	546.00
1526	24/29	727.00
1527	29/32	790.00
1528	34/35	886.00

SMV-B-88 Collapsible Paddle Glass Stirrer

Cat No.	Shaft Dia	Shaft Length	Bladewidth	Price
1529	8 mm	600 mm	70 mm	2,200.00
1530	10 mm	600 mm	70 mm	2,200.00

SMV-B-89 Fixed Paddle Glass Stirrers

Cat No.	Shaft Dia	Shaft Length	Blade width	Price
1531	8 mm	600 mm	70 mm	2,200.00
1532	10 mm	600 mm	70 mm	2,200.00

SMV-B-90 Anchor Glass Stirrers

Cat No.	Shaft Dia	Shaft Length	Blade width	Price
1533	8 mm	600 mm	70 mm	2,200.00
1534	10 mm	600 mm	70 mm	2,200.00

SMV-B-91 Anchor Stirrer Flat Glass Fungel

Cat No.	Shaft Dia	Shaft Length	Blade width	Price
1535	8 mm	600 mm	70 mm	2,200.00
1536	10 mm	600 mm	70 mm	2,200.00

SMV-B-92 Anchor Stirrer Glass Flat

Cat No.	Shaft Dia	Shaft Length	Blade width	Price
1537	8 mm	600 mm	70 mm	2,200.00
1538	10 mm	600 mm	70 mm	2,200.00

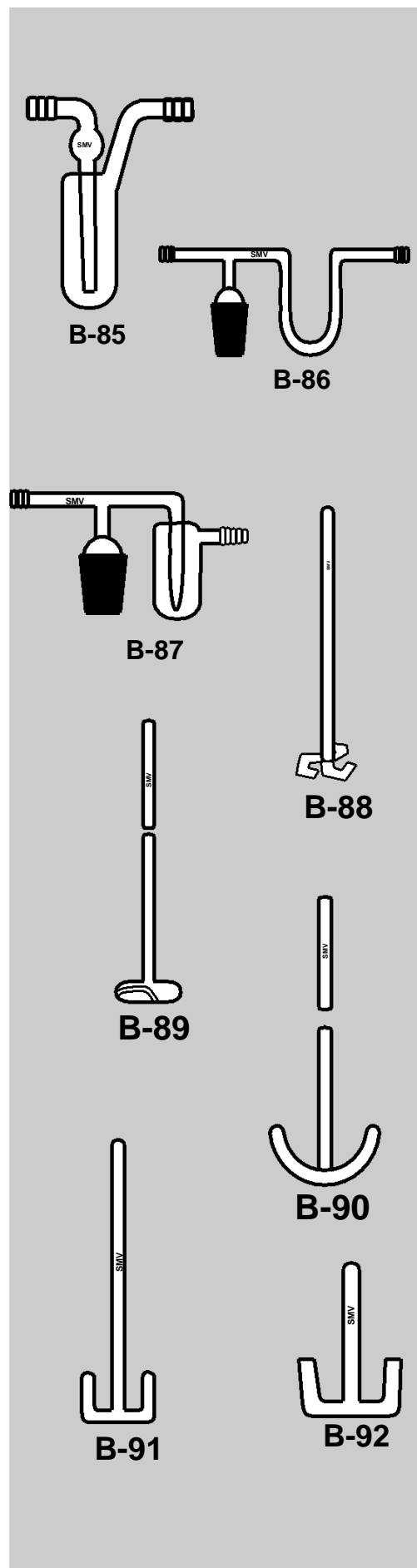

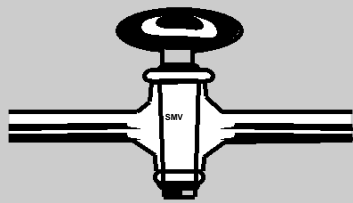

B-93

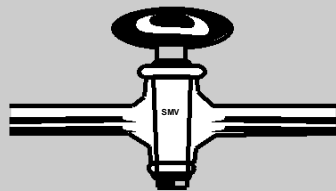

B-94

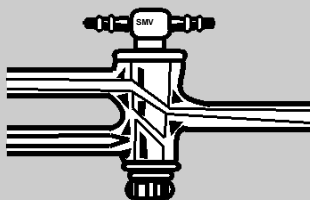

B-95

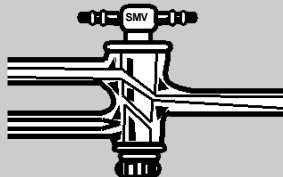

B-96

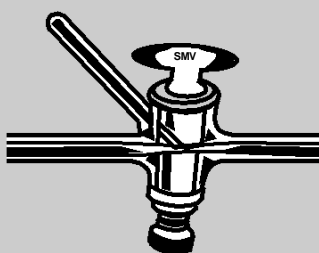

B-97

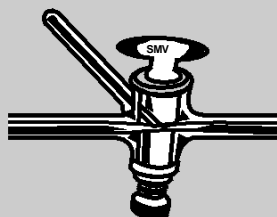

B-98

SMV-B-93 Stopcocks, Straight Bore Glass

Cat No.	Bore MM	Tube Dia mm	Price
1539	1	2	400.00
1540	2	8	400.00
1541	3	8	400.00
1542	4	10	600.00
1543	6	12	900.00
1544	8	15	1,400.00

SMV-B-94 Stopcocks, Straight Bore PTFE Plug

Cat No.	Bore MM	Tube Dia mm	Price
1545	1	8	700.00
1546	2	8	700.00
1547	3	8	700.00
1548	4	10	850.00
1549	8	12	1,200.00
1550	10	15	1,400.00

SMV-B-95 Stopcocks, Double Oblique Bore

Cat No.	Bore MM	Tube Dia mm	Price
1551	1	8	700.00
1552	2	8	700.00
1553	3	8	700.00
1554	4	10	850.00
1555	8	12	1,200.00
1556	10	15	1,800.00

SMV-B-96 Stopcocks, Double Oblique Box PTFE

Cat No.	Bore MM	Tube Dia mm	Price
1557	1	8	850.00
1558	2	8	850.00
1559	3	8	850.00

SMV-B-97 Stopcock's 'T' Bore

Cat No.	Bore MM	Tube Dia mm	Price
1560	1	8	800.00
1561	2	8	800.00
1562	3	8	800.00
1563	4	10	850.00
1564	6	12	950.00
1565	8	15	1,300.00

SMV-B-98 Stopcock's 'T' Bore, PTFE Plug

Cat No.	Bore MM	Tube Dia mm	Price
1566	1	8	950.00
1567	2	8	950.00
1568	3	8	950.00
1569	4	10	1,050.00
1570	6	12	1,050.00
1571	8	15	1,450.00

SMV-B-99 Seal Tube with PTFE Cap

Cat No.	Capacity ml.	Price
1572	15	P.O.R
1573	30	P.O.R
1574	50	P.O.R
1575	100	P.O.R
1576	150	P.O.R
1577	250	P.O.R
1578	500	P.O.R

SMV-C-1 Manifold, Vacuum, Glass Stopcock Single

Cat No.	No.of Ports	Price
1579	3	2,090.00
1580	4	2,750.00
1581	5	3,410.00
1582	6	4,180.00

SMV-C-2 Manifold, Vacuum, Double Glass Stopcock

Cat No.	No.of Ports	Price
1583	3	5,280.00
1584	4	6,160.00
1585	5	8,580.00
1586	6	10,500.00

SMV-C-3 Manifold, Vacuum Double Teflon Plug

Cat No.	No.of Ports	Price
1587	3	8,500.00
1588	4	9,460.00
1589	5	10,670.00
1590	6	12,500.00

SMV-C-4 Gooch Crucibles

Cat No.	Cap Ml	Disc Dia mm	Price
1591	15	20 G1	226.00
1592	15	20 G2	226.00
1593	15	20 G3	226.00
1594	15	20 G4	226.00
1595	30	30 G1	283.00
1596	30	30 G2	283.00
1597	30	30 G3	283.00
1598	30	30 G4	283.00
1599	50	40 G1	356.00
1600	50	40 G2	356.00
1601	50	40 G3	356.00
1602	50	40 G4	356.00



B-99

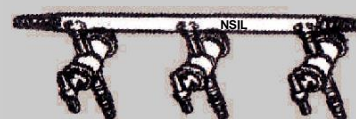

C-1

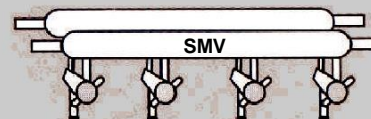

C-2

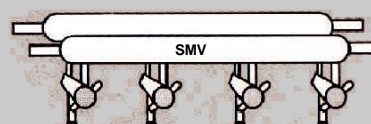

C-3



C-4



C-5

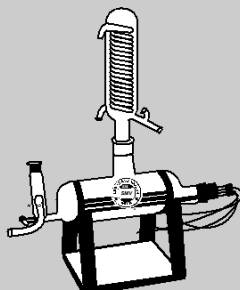

C-6

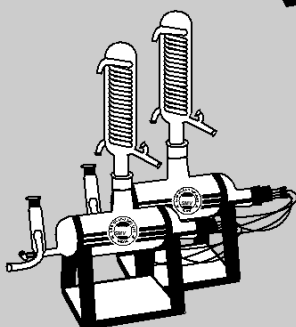

C-7

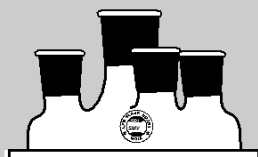

C-8



C-9

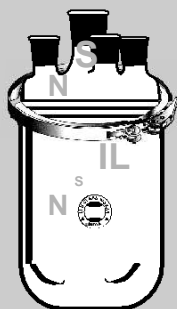

C-10

SMV-C-5 Distillation receiver with multiple bend

Cat No.	Cap.ml	Joint	Price
1603	100 ml	B14	1,800.00
1604	100 ml	B19	1,800.00
1605	250 ml	B19	2,200.00
1606	250 ml	B24	2,200.00

SMV-C-6 Single Distillation Apparatus Glass

Cat No.	Cap.ml/Ltr	Price
1607	1.5 Ltr	P.O.R
1608	4 Ltr	P.O.R
1609	5 Ltr	P.O.R
1610	10 Ltr	P.O.R

SMV-C-7 Double Distillation Apparatus Glass

Cat No.	Cap.ml/Ltr	Price
1611	1.5 Ltr	P.O.R
1612	4 Ltr	P.O.R
1613	5 Ltr	P.O.R
1614	10 Ltr	P.O.R

SMV-C-8 Reaction Vessel with Lid four neck flat Flange (Kettle)

Cat No.	Cap. MI	Price
1615	250	3,500.00
1616	500	3,900.00
1617	1000	4,200.00
1618	2000	5,000.00

SMV-C-9 Reaction Vessel Cylindrical with flat Flange (Kettle)

Cat No.	Cap. MI	Price
1619	250	2,500.00
1620	500	3,000.00
1621	1000	3,500.00
1622	2000	4,000.00

SMV -C-10 Reaction Vessels, Cylindrical with Flat Flange (Set)

Cat No.	Cap. MI	Price
1623	250	16,000.00
1624	500	17,000.00
1625	1000	18,000.00
1626	2000	19,600.00

Nsil -C-11

Cat No.
1627
1628
1629
1630

SMV –C-12 Jacketed Reaction Vessel Stand

Cat No.	Size	Price
1631	Jacketed Reaction Vessel Stand SS 500ml to 1Ltr	P.O.R
1631	Jacketed Reaction Vessel Stand SS 2Ltr to 5Ltr	P.O.R

SMV –C-13 Jacketed Reaction Vessel in Cylindrical body (set)

Cat No.	Cap. Ml	Price
1633	250	20,000.00
1634	500	22,600.00
1635	1000	24,500.00
1636	2000	26,500.00

SMV –C-14 Jacketed Reaction Vessel with buffe in cylindrical body (set)

Cat No.	Cap. Ml	Price
1637	250	22,200.00
1638	500	24,700.00
1639	1000	26,900.00
1640	2000	28,900.00

SMV –C-15 Reaction Vessel with buffe in cylindrical body (Set)

Cat No.	Cap. Ml	Price
1641	250	14,200.00
1642	500	14,500.00
1643	1000	14,900.00
1644	2000	16,300.00

SMV –C-16 Gasket for Reaction Vessel Silcon O ring

Cat No.	Arm Length X Dia mm	Price
1645	100 mm	600.00
1646	120 mm	750.00
1647	160 mm	1,200.00

SMV-C-17 Reflux Divider Apparatus

Cat No.	Size	Price
1648	34/35 - 34/35	5,200.00
1648 A	24/29 - 24/29	5,200.00

SMV-C-18 Reaction Vessel with Lid four neck flat flange (Kettle)

Cat No.	Cap. Ml	Price
1649	250	3,500.00
1650	500	3,900.00
1651	1000	4,200.00
1652	2000	5,000.00



C-12



C-13

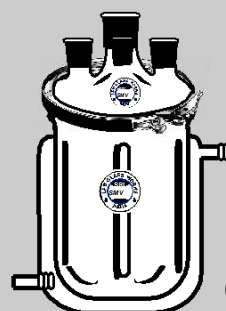

C-14



C-15



C-16

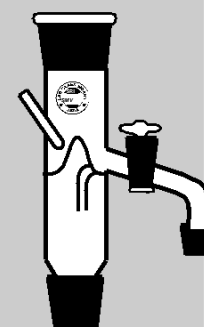

C-17

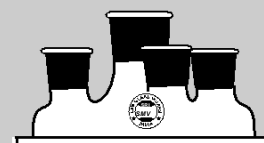

C-18

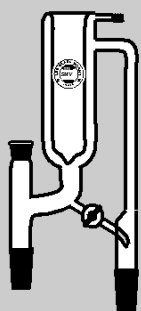

C-19



C-20



C-21

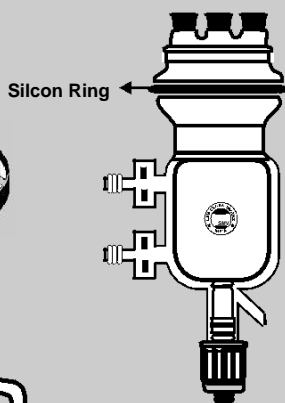

Silicon Ring

C-22

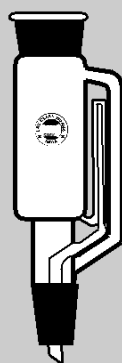

C-23

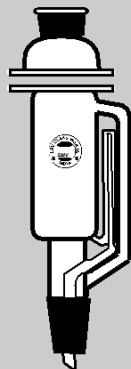

C-24

SMV-C-19 Distilling Head, Style used for low Boiling point solvents

Cat No.	Flask Joint	Approx Height X Width mm	Price
1653	24/29	360x200	10,580.00
1654	29/32	360x300	10,580.00

SMV-C-20 Reaction, Vessel, Clamp, flat flange with support

Cat No.	Cap MI	Price
1655	250	P.O.R
1656	500	P.O.R
1657	1000	P.O.R
1658	2000	P.O.R

SMV-C-21 Reaction Vessel with Lid four neck flat flange (Kettle)

Cat No.	Cap MI	Price
1659	250	3,500.00
1660	500	3,900.00
1661	1000	4,200.00
1662	2000	5,000.00

SMV - C-22 Reaction Vessel, Cylindrical jacketed with Bottom outlet (Complete set)

Cat No.	Cap MI	Price
1663	250	38,800.00
1664	500	42,200.00
1665	1000	60,259.00
1666	2000	61,200.00

SMV-C-23 Extractor only for Sox let Apparatus

Cat No.	Cap.ml	Socket	Cone	Price
1667	60	34/35	24/29	850.00
1668	100	34/35	24/29	1,800.00
1669	100	40/38	24/29	1,900.00
1670	200	50/42	24/29	2,400.00
1671	250	50/42	24/29	2,450.00
1672	500	50/42	24/29	4,000.00

SMV-C-24 Large Size Extractor

Cat No.	Size	ml.	Price
1673	75 mm	600	4,620.00
1674	100 mm	1000	7,280.00
1675	100 mm	2000	13,490.00

**SMV-C-25 Flasks Glass (Vessels) Reaction Wide Mouth Flat Flange,
100 mm, ID 150 mm OD**

Cat No.	Capacity ml	Price
1676	1000	12,000.00
1677	2000	12,000.00
1678	3000	16,000.00
1679	5000	16,000.00
1680	10000	18,000.00
1681	20000	22,000.00



C-25

SMV-C-26 Lid Glass 4 necks

Cat No.	Capacity ml	Price
1682	1000 for Center B 24 neck Side B 19	3,700.00
1683	2000 for Center B 24 neck Side B 24	3,700.00
1684	3000 for Center B 34 neck Side B 24	3,700.00
1685	5000 for Center B 34 neck Side B 24	3,700.00
1686	10000 for Center B 34 neck Side B 24	3,700.00
1687	20000 for Center B 34 neck Side B 24	3,700.00

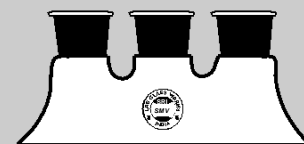

C-26

SMV-C-27 Clip for Holding Flat Range 1000 ml to 20 Ltr Price

1688	2,850.00
------	----------

General and QC



C-28

SMV-C-28 Pipettes Volumetric Class "B"

Cat No.	Cap. MI	Price
1689	1	110.00
1690	2	110.00
1691	5	110.00
1692	10	110.00
1693	20	130.00
1694	25	130.00
1695	50	170.00

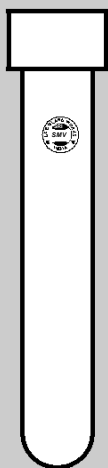

C-29

SMV-C-29 Test Tubes with Screw cap Plain

Cat No.	Cap. MI	Price
1696	5	34.00
1697	10	40.00
1698	20	120.00
1699	30	140.00
1700	40	160.00
1701	50	180.00
1702	100	210.00

SMV-C-30 Test Tubes with Screw Cap Graduated

Cat No.	Cap. Ml	Price
1703	5	60.00
1704	10	120.00
1705	20	150.00
1706	30	160.00
1707	40	135.00
1708	50	165.00
1709	100	210.00

SMV-C-31 Test Tubes with Stopper Plain

Cat No.	Cap. Ml	Price
1710	10	80.00
1711	20	120.00
1712	30	130.00
1713	40	178.00
1714	50	220.00
1715	100	250.00

SMV-C-32 Test Tubes with Stopper Graduated

Cat No.	Cap. Ml	Price
1716	10	119.00
1717	20	138.00
1718	30	210.00
1719	40	230.00
1720	50	270.00
1721	100	290.00

SMV-C-33 Test Tubes with Rim

Cat No.	Size	Capacity ml	Price
1722	10x75	5 ml	9.00
1723	12x75	10 ml	9.00
1724	12x100	10 ml	13.00
1725	15x125	15 ml	16.00
1726	15x150	20 ml	19.00
1727	18x150	25 ml	20.00
1728	25x100	50 ml	30.00
1729	25x150	75 ml	30.00
1730	25x200	100 ml	48.00

SMV-C-34 Beakers with Spout and Graduated

Cat No.	Capacity ml	Price
1731	5 ml	65.00
1732	10 ml	70.00
1733	25 ml	80.00
1734	50 ml	65.00
1735	100 ml	75.00
1736	150 ml	82.00
1737	250 ml	90.00
1738	500 ml	140.00
1739	1000 ml	330.00
1740	2000ml	550.00

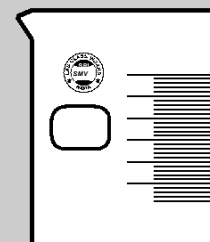
**C-30****C-31****C-32****C-33****C-34**

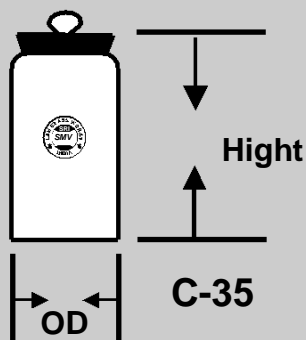

C-35

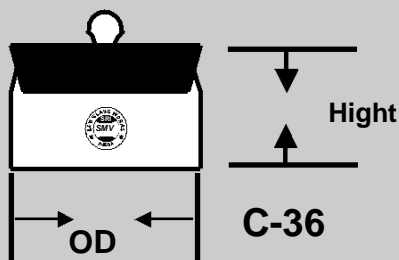

C-36

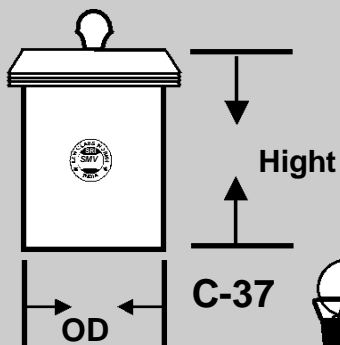

C-37



C-38

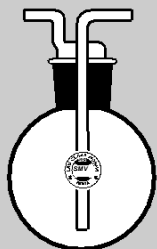

C-39

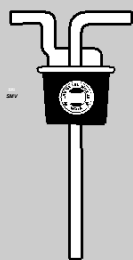

C-40

SMV – C-35 Weighing Bottles, Tall Form, Common Type

Cat. No.	Ht.X Dia. Mm	Approx. Cap.ml	Joint Size	Price
1741	50x25	15 ml	24/10	148.00
1742	50x25	15 ml	24/10	172.00
1743	60x30	25 ml	29/12	197.00
1744	60x30	60 ml	40/13	310.00
1745	80x40	80 ml	55/15	500.00
1746	80x60	100 ml	55/15	600.00

SMV – C-36 Weighing (LOD) Bottles, Squat Form,

Cat. No.	Ht.X Dia. Cap.ml	Approx. Size	Joint	Price
1747	25x20	5ml	40/13	220.00
1748	35x40	20 ml	40/13	490.00
1749	35x50	30 ml	50/14	685.00
1750	35x60	40 ml	55/15	690.00
1751	40X90	60ml	55x15	700.00

SMV – C-37 Weighing Bottles, Tall Form, Cap Type

Cat. No.	Ht.X Dia. Mm	Approx. Cap.ml	Joint Size	Price
1752	40x20	5 ml	19/10	148.00
1753	50x25	15 ml	24/10	172.00
1754	60x30	25 ml	29/12	197.00
1755	80x40	60 ml	40/13	400.00
1756	80x50	100 ml	55/15	500.00

SMV – C-38 Bottles B.O.D with Interchangeable Stopper

Cat. No.	Capacity ml	Approx O.D x Height*mm	Price
1757	125	55x120	385.00
1758	300	70x145	460.00

SMV – C-39 Wash , Bottles Complete

Cat. No.	Cap.ml	Joint Size	Price
1759	250	24/29	450.00
1760	500	24/29	570.00
1761	1000	29/32	750.00

SMV – C-40 Wash Bottle Fitting Only

Cat. No.	For Cap.ml	Price
1762	250 B-24	270.00
1763	500 B-29	270.00
1764	1000 B-29	270.00

**SMV – C-41 Gas Washing Bottles, Ordinary Complete
(Joint Size 29/32) Heavy Wall**

Cat. No.	For Cap.ml	Price
1765	125	600.00
1766	250	700.00
1767	500	900.00
1768	1000	1,636.00

**SMV – C-42 Gas Washing Bottles, Bottles Only
(Joint Size 29/32) Heavy Wall Tube**

Cat. No.	For Cap.ml	Price
1769	125	299.00
1770	250	373.00
1771	500	576.00
1772	1000	1,118.00

SMV – C-43 Gas Washing Bottles, Fitting Only (Joint Size 29/32)

Cat. No.	For Cap.ml	Price
1773	125	200.00
1774	250	202.00
1775	500	250.00
1776	1000	280.00

**SMV – C-44 Gas Washing Bottles, With Sintered end
D/W, G/Dist, (Joint Size 29/32)**

Cat. No.	For Cap.ml	Joint Size	Price
1777	125	0,1,2,3	609.00
1778	250	0,1,2,3	693.00
1779	500	0,1,2,3	928.00
1780	1000	0,1,2,3	1,250.00

**SMV – C-45 Gas Washing Bottles, With Sintered end
U/W, G/Dist N/Mouth (Joint Size 29/32)**

Cat. No.	For Cap.ml	Disc Por	Price
1781	125	0,1,2,3	645.00
1782	250	0,1,2,3	732.00
1783	500	0,1,2,3	964.00
1784	1000	0,1,2,3	1,250.00
1785	100	0,1,2,3	645.00
1786	250	0,1,2,3	732.00
1787	500	0,1,2,3	964.00
1788	1000	0,1,2,3	1,250.00



C-41



C-42

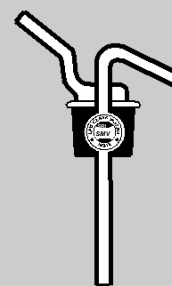

C-43



C-44



C-45



C-46



C-47

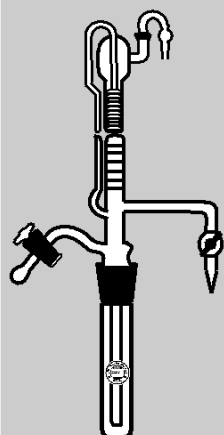

C-48

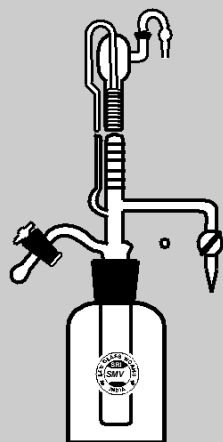

C-49



C-50

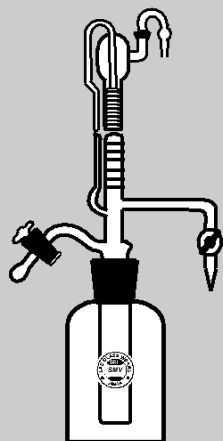

C-51

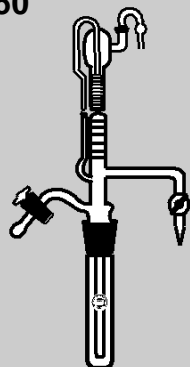

C-52

SMV – C-46 Dropping Bottle With Pipette Stopper Plain

Cat. No.	For Cap.ml	Joint Size	Price
1789	30	14/15	345.00
1790	50	14/15	399.00
1791	125	19/20	400.00

SMV – C-47 Dropping Bottle With Pipette Stopper Graduated

Cat. No.	For Cap.ml	Joint Size	Price
1792	30	14/15	360.00
1793	50	14/15	390.00
1794	125	19/20	480.00

SMV – C-48 Burette Automatic Screw Type Class A only Burette

Cat. No.	For Cap.ml	Price
1795	10 ml	4,000.00
1796	25 ml	4,000.00
1797	50 ml	4,000.00

SMV – C-49 Burettes Automatic Screw Type Class A With Guard Tube & Bottle Complete

Cat. No.	For Cap.ml	Price
1798	10 ml	5,600.00
1799	25 ml	5,600.00
1800	50 ml	5,800.00
1801	100ml	7,750.00

SMV – C-50 Burettes Automatic Screw Type Class A (AMBER) With Guard Tube & Bottle Complete

Cat. No.	For Cap.ml	Price
1802	10 ml	P.O.R
1803	25 ml	P.O.R
1804	50 ml	P.O.R
1805	100ml	P.O.R

SMV – C-51 Burette Automatic Screw Type Class B only Burette

Cat. No.	For Cap.ml	Price
1806	10 ml	2,500.00
1807	25 ml	2,500.00
1808	50 ml	2,500.00

SMV – C-52 Burettes Automatic Screw Type Class B With Guard Tube & Bottle Complete

Cat. No.	For Cap.ml	Price
1809	10 ml	4,000.00
1810	25 ml	4,000.00
1811	50 ml	4,000.00
1812	Rubber Bellow Single Bellow	350.00

SMV – C-53 Burettes Straight Bore Class B

Cat. No.	Capacity ml	Price
1813	1 ml	417.00
1814	2 ml	417.00
1815	5 ml	417.00
1816	10 ml	430.00
1817	25 ml	430.00
1818	50 ml	450.00
1819	100 ml	600.00

SMV – C-54 Burettes Straight Bore Class A

Cat. No.	Capacity ml	Price
1820	1 ml	1,640.00
1821	2 ml	1,690.00
1822	5 ml	1,690.00
1823	10 ml	1,870.00
1824	25 ml	1,870.00
1825	50 ml	1,950.00
1826	100 ml	2,600.00

SMV – C-55 Conical Flasks Plain Narrow Neck Graduated

Cat. No.	Cap.ml/Ltr	Price
1827	10 ml	65.00
1828	25 ml	102.00
1829	50 ml	107.00
1830	100 ml	109.00
1831	150 ml	112.00
1832	250 ml	120.00
1833	500 ml	170.00
1834	1000 ml	250.00
1835	2000 ml	500.00

SMV – C-56 Iodine Flasks, Cup Shaped

Cat. No.	For Cap.ml	Joint	Price
1836	100	24/29	229.00
1837	250	24/29	264.00
1838	500	24/29	295.00
1839	1000	24/29	490.00

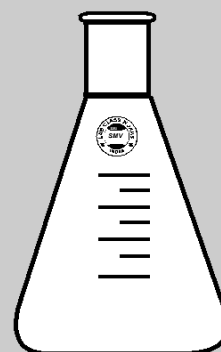
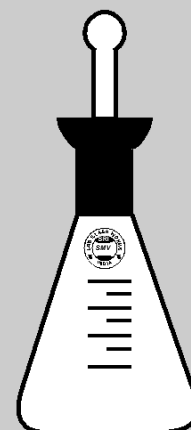
**C-53****C-54****C-55****C-56**



C-57

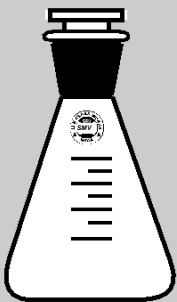

C-58



C-59



C-60

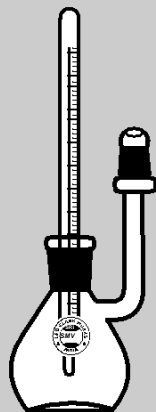

C-60A

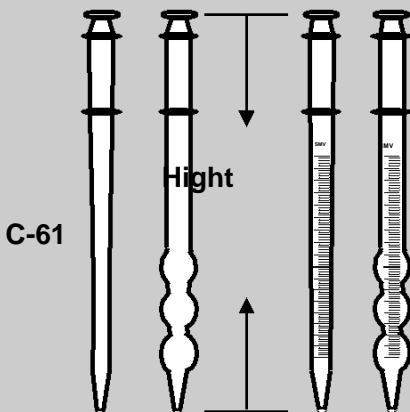

C-61

C-62

SMV – C-57 Iodine Flasks, B.S.Type

Cat. No.	For Cap.ml	Joint	Price
1840	250	24/29	382.00
1841	500	24/29	445.00
1842	1000	24/29	571.00

SMV – C-58 Stoppard Conical Flasks

Cat. No.	For Cap.ml	Joint	Price
1843	100	19/20	270.00
1844	150	24/25	270.00
1845	250	24/25	370.00
1846	500	24/25	490.00
1847	1000	24/29	600.00

SMV - C-59 Specific Gravity Bottles 1/C Stopper "B"

Cat No.	Cap.ml	Price
1848	25	300.00
1849	50	350.00

SMV - C-60 Specific Gravity Bottles 1/C Stopper With Teflon

Cat No.	Cap.ml	Price
1850	25	870.00
1851	50	920.00

SMV-C-60A Specific Gravity Bottles With Ground in thermometer range 0 to 50 C Class A

Cat No.	Cap.ml	Price
1850A	25	1,800.00
1851B	50	2,100.00

SMV-C-61 Drum Samplers Glass

Cat No.	Size/Feet	Price
1852	2	550.00
1853	3	650.00
1854	4	750.00
1855	5	950.00

SMV-C-62 Drum Samplers Glass with Graduation

Cat No.	Size/Feet	Cap.Ml	Price
1856	2	50	1,300.00
1857	3	75	1,500.00
1858	4	125	1,800.00

SMV-C-63 Crystallizing dishes OD Height Glass bowl

Cat No.	Approx	Price
1860	100x50	350.00
1861	150x75	1,200.00
1862	190x100	1,400.00

SMV-C-64 Crystallizing dishes OD Height (Petri dishes)

Cat No.	Approx	Price
1863	50x17 2"	120.00
1864	80x17 3"	160.00
1865	100x20 4"	220.00
1866	150x20 6"	475.00
1867	200x20 8"	700.00

SMV-C-65 Drying Trays Heavy Wall

Cat No.	Approx Dimension mm	Apporox Capacity ml	Price
1868	400x257x61	3500	1,310.00
1869	386x217x63	3000	950.00
1870	350x200x58	2400	950.00
1871	320x180x51	1500	930.00
1872	254x209x57	1600	900.00
1873	256x220x60	2000	930.00
1874	286x120x80	1200	900.00

SMV-C-66 Filtration Flasks Heavy Wall

Cat No.	Capacity ml	Price
1875	25 ml	220.00
1876	50 ml	250.00
1877	100 ml	350.00
1878	250 ml	800.00
1879	500 ml	1,050.00
1880	1000 ml	1,400.00
1881	2000 m	1,800.00
1882	5000 ml	7,500.00
1883	10 Ltr	10,500.00
1884	20 Ltr	14,500.00

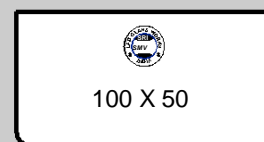
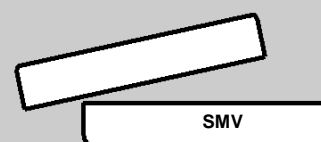
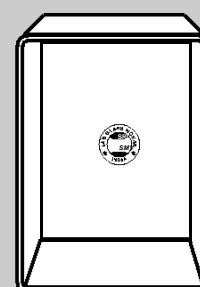
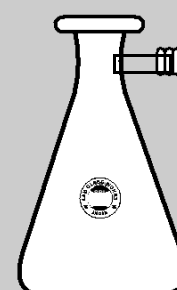
**C-63****C-64****C-65****C-66**



C-67



C-68

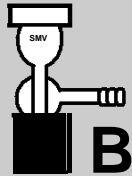

B

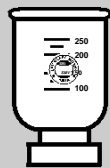

A

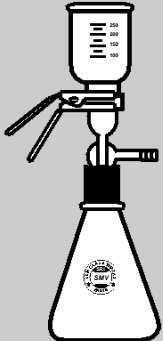

C-69



C,D

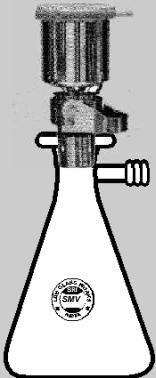

C-71

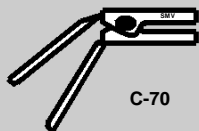

C-70

SMV-C-67 Filtration Rubber Cones Red

Cat No.	Capacity ml	Price
1885	50	40.00
1886	100	60.00
1887	250	60.00
1888	500	60.00
1889	1000	60.00
1890	2000	98.00
1891	5 Ltr	250.00
1892	10 Ltr	310.00

SMV-C-68 Filtration Rubber Bunks Solid

Cat No.	Size ml	Price
1893	250	100.00
1894	500	100.00
1895	1000	250.00
1896	2000	250.00
1897	5000	800.00
1898	10000	800.00
1899	20000	800.00

SMV-C-69 Micro Filtration Assembly with Ground glass joint

Cat No	Size mm	Cap.ml	Price
1900	47	1000 ml complete set	9,000.00
1901	47	2000 ml complete set	11,000.00
1902	47	5000 ml complete set	47,000.00
1903 A	47	300 ml	1,600.00
1904 B	47	B34 or B40 Joint	2,820.00
1905 C		B34 or B40 Joint	2,400.00
1906 D		B34 or B40 Joint	2,800.00

SMV-C-70 Clamp 47 size spare

Cat No.	Size	Price
1907	47	746.00

SMV-C-71 S.S Membrane Filter Holder Assembly 47 mm

Cat No.	Capacity ml	Size	Price
1908	500 Complete Set	47	P.O.R
1909	1000 Complete Set	47	P.O.R
1910	2000 Complete Set	47	P.O.R
1911	5000 Complete Set	47	P.O.R

SMV-C-72 Reagent Bottle with IC Stopper

Cat No.	Capacity ml	Price
1912	50 ml	275.00
1913	125 ml	300.00
1914	250 ml	305.00
1915	500 ml	330.00
1916	1000 ml	480.00
1917	2000 ml	805.00

SMV-C-73 Reagent Bottle with IC Stopper Amber Color

Cat No.	Capacity ml	Price
1918	50 ml	425.00
1919	100 ml	479.00
1920	250 ml	479.00
1921	500 ml	505.00
1922	1000 ml	612.00
1923	2000 ml	833.00

SMV-C-74 Laboratory bottle with dean thread, graduated with PP Screw cap Blue

Cat No.	Capacity ml	Price
1924	25	230.00
1925	50	250.00
1926	100	280.00
1927	250	280.00
1928	500	290.00
1929	1000	450.00
1930	2000	790.00
1931	5000	P.O.R
1932	10000	P.O.R
1933	20000	P.O.R

SMV-C-75 Laboratory bottle with dean thread, graduated with PP Screw cap Blue Amber color

Cat No.	Capacity ml	Price
1934	25	360.00
1935	50	390.00
1936	100	450.00
1937	250	490.00
1938	500	550.00
1939	1000	750.00
1940	2000	1,300.00
1941	5000	P.O.R
1942	10000	P.O.R
1943	20000	P.O.R

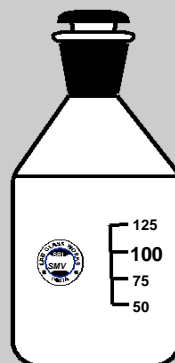

C-72

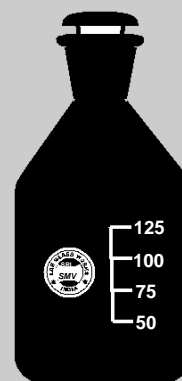

C-73



C-74



C-75

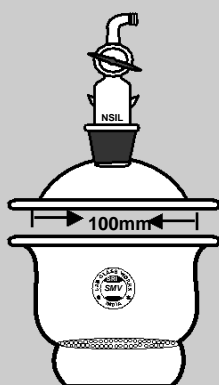

C-76

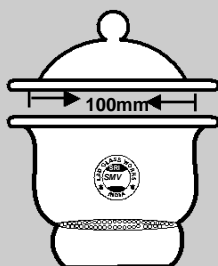

C-77

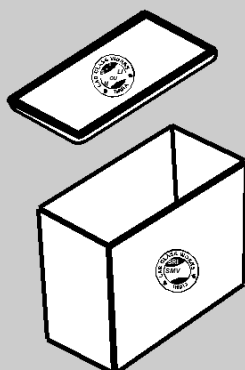

C-78

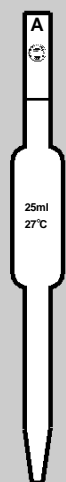

C-79

SMV-C-76 Desiccators Vacuum ID mm

Cat No.	ID mm	Price
1944	100	8,000.00
1945	150	12,000.00
1946	200	13,000.00
1947	250	16,000.00
1948	300	22,000.00

SMV-C-77 Desiccators Plain ID mm

Cat No.	ID mm	Price
1949	100	5,000.00
1950	150	6,000.00
1951	200	8,000.00
1952	250	10,000.00
1953	300	14,000.00

SMV-C-78 Museum jar with ground in glass plate (Preparative TLC chamber)

Cat No.	ID mm Height	Price
1954	150x150x50 mm	10,000.00
1955	250x250x140 mm	14,000.00

SMV-C-79 Volumetric Pipettes (Bulb) CLASS 'A'

Cat No.	Cap Ml	Price
1960	1	295.00
1961	2	300.00
1962	3	300.00
1963	4	300.00
1964	5	335.00
1965	6	335.00
1966	7	335.00
1967	8	335.00
1968	9	335.00
1969	10	405.00
1970	20	525.00
1971	25	560.00
1972	50	640.00
1973	100	850.00

SMV-C-80 Volumetric Pipettes (Bulb) CLASS 'B'

Cat No.	Cap Ml	Price
1974	1	120.00
1975	2	120.00
1976	3	120.00
1977	4	120.00
1978	5	120.00
1979	6	150.00
1980	7	150.00
1981	8	150.00
1982	9	150.00
1983	10	150.00
1984	20	150.00
1985	25	170.00
1986	50	190.00
1987	100	200.00

SMV-C-81 Graduation Pipettes CLASS 'A'

Cat No.	Cap Ml	Price
1988	0.1	270.00
1989	0.2	270.00
1990	1	241.00
1991	2	252.00
1992	5	294.00
1993	10	312.00
1994	25	369.00

SMV-C-82 Pipettes Graduated, Class 'B'

Cat No.	Cap Ml	Price
1995	0.1	120.00
1996	0.2	120.00
1997	0.5	120.00
1998	1	120.00
1999	2	130.00
2000	5	140.00
2001	10	140.00
2002	25	175.00

SMV-C-83 Volumetric Flask Class 'A'

Cat No.	Cap Ml	Price
2003	1	735.00
2004	2	740.00
2005	5	750.00
2006	10	750.00
2007	20	750.00
2008	25	750.00
2009	50	750.00
2010	100	750.00
2011	200	750.00
2012	250	750.00
2013	500	1,050.00
2014	1000	1,480.00
2015	2000	2,200.00

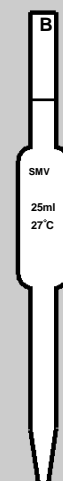

C-80



C-81



C-82

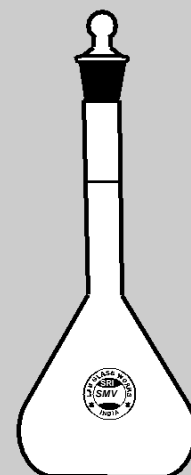

C-83

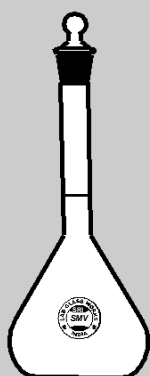

C-84

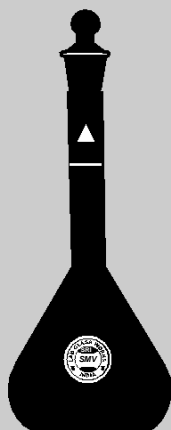

C-85

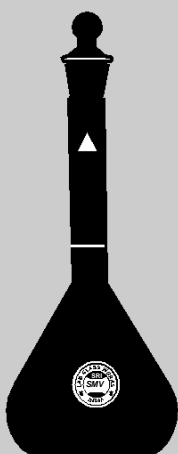

C-86



C-87

SMV-C-84 Volumetric Flask with I/c Stopper Class B

Cat No.	Cap ML	Size	Price
2016	5	10/15	220.00
2017	10	10/15	210.00
2018	25	10/15	215.00
2019	50	10/15	230.00
2020	100	14/15	240.00
2021	250	14/15	340.00
2022	500	19/20	450.00
2023	1000	24/20	630.00
2024	2000	24/20	1,120.00

SMV-C-85 Volumetric Flask Class 'A' with Amber Colour

Cat No.	Cap ML	Size	Price
2025	5	10/15	765.00
2026	10	10/15	670.00
2027	20	10/15	670.00
2028	25	10/15	605.00
2029	50	10/15	605.00
2030	100	14/15	645.00
2031	200	14/15	805.00
2032	250	14/15	815.00
2033	500	19/20	1115.00
2034	1000	19/20	1,655.00
2035	2000	24/25	2,605.00

SMV-C-86 Volumetric Flask Class 'B' with Amber Colour

Cat No.	Cap ML	Size	Price
2036	5	10/15	315.00
2037	10	10/15	300.00
2038	20	10/15	300.00
2039	25	10/15	285.00
2040	50	10/15	300.00
2041	100	14/15	330.00
2042	200	14/15	375.00
2043	250	14/15	385.00
2044	500	19/20	550.00
2045	1000	19/20	865.00
2046	2000	24/25	1,475.00

SMV-C-87 Measuring Cylinders Class 'A'

Cat No.	Cap ML	Price
2047	5	450.00
2048	10	490.00
2049	25	600.00
2050	50	680.00
2051	100	865.00
2052	250	1,300.00
2053	500	1,650.00
2054	1000	1,950.00
2055	2000	3,730.00

SMV-C-88 Measuring Cylinders with Stopper Class 'A'

Cat No.	Cap Ml	Price
2056	5	610.00
2057	10	690.00
2058	25	790.00
2059	50	900.00
2060	100	1,090.00
2061	250	1,700.00
2062	500	2,100.00
2063	1000	2,550.00
2064	2000	4,400.00

SMV-C-89 Measuring Cylinder Medium wall Class 'B'

Cat No.	Cap Ml	Price
2065	5	170.00
2066	10	230.00
2067	25	290.00
2068	50	310.00
2069	100	340.00
2070	250	470.00
2071	500	770.00
2072	1000	957.00
2073	2000	1,800.00

SMV-C-90 Measuring Cylinder with l/c Stopper Class 'B'

Cat No.	Cap Ml	Price
2074	5	215.00
2075	10	337.00
2076	25	320.00
2077	50	390.00
2078	100	420.00
2079	250	594.00
2080	500	890.00
2081	1000	1,201.00
2082	2000	2,055.00

SMV-C-91 Nessler Cylinder Medium wall Class 'B'

Cat No.	Cap Ml	Price
2083	50	170.00
2084	100	190.00

SMV-C-92 Liphyizer Tube one mark 50 mm form bottom

Cat No	Dia x Length	Price
2085	9 x 170	25.00

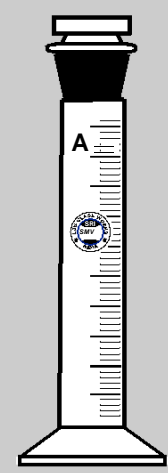

C-88

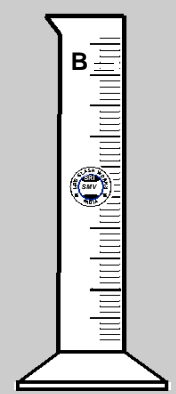

C-89



C-90



C-91



C-92



C-93



C-94

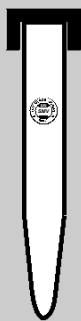

C-95



C-96

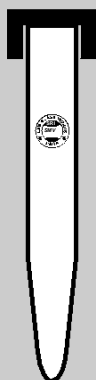

C-97



C-98



C-99

SMV-C-93 Centrifuge Tubes Conical bottom, Plain.

Cat No.	Cap MI	Ht.xO.D.mm	Price
2086	3	76x10	24.00
2087	5	100x13	30.00
2088	10	110x15	37.00
2089	12	110x16	37.00
2090	15	120x17	37.00
2091	25	125x27	124.00
2092	50	125x28	160.00

SMV-C-94 Centrifuge Tubes Conical Bottom, graduated.

Cat No.	Cap MI	Ht.xO.D.mm	Price
2093	5	100x13	47.50
2094	10	110x15	57.00
2095	15	120x17	68.00
2096	25	125x22	150.00
2097	50	125x28	184.00

SMV-C-95 Centrifuge Tubes Conical Bottom with screw cap, Plain

Cat No.	Cap MI	Ht.xO.D.mm	Price
2098	10	110x15	102.00
2099	15	120x17	108.00

SMV-C-96 Centrifuge Tubes round bottom with screw cap, Graduated

Cat No.	Cap MI	Ht.xO.D.mm	Price
2100	10	110x15	122.00
2101	15	110x17	130.00

SMV-C-97 Centrifuge Tubes Conical bottom with screw cap, Graduated

Cat No.	Cap MI	Ht.xO.D.mm	Price
2102	10	110x1	116.00
2103	12	110x16	122.00
2104	15	120x17	124.00
2105	25	125x22	196.00
2106	51	25x28	260.00

SMV-C-98 Centrifuge Tubes Conical bottom with Interchangeable Stopper graduated

Cat No.	Cap MI	Ht.xO.D.mm	Price
2107	10	110x15	132.00
2108	15	120x17	152.00
2109	25	125x22	250.00
2110	50	125x28	320.00

SMV-C-99 Melting Point Tubes One Side Open

Cat No.	Length in mm	Price Pkt. of	100 Nos.
2111	80 mm		145.00
2112	100 mm		145.00

SMV-D-1 Melting Point Tubes Two Side Open

Cat No.	Length in mm	Price Pkt.of	100 Nos.
2113	80 mm		145.00
2114	100 mm		145.00

SMV-D-2 TLC Capillary Tubes

Cat No.	Size	Price/Kg
2115		
2116		
2117	TLC Capillary Tubes 10" (0.2 mm Bore)	9,000.00

SMV-D-3 TLC Capillary Graduation 5 mul Single mark

Cat No.	Mul Single Mark	Price per Box
2118	5	900.00
2119	10	1200.00

SMV-D-4 TLC Chamber with Lid Dia

Cat No.	Dia x Length mm	Price
2120	40x100	450.00
2121	50x100	550.00
2122	60x100	885.00
2123	65x105	1,015.00
2124	82x120	1,250.00
2125	50x80	885.00
2126	45x80	550.00

SMV-D-5 Sample Vials per pack

Cat No.	Capacity ml	Quantity per pack	Price
2127	5	144	350.00
2128	10	144	450.00

SMV-D-6 Tubes. Culture, Media, Flat Bottom, With Screw Cap

Cat No.	Approx O.D. X Length mm	Cap.ML	Price
2129	16x75	5	60.00
2130	16x125	10	70.00
2131	25x100	20	75.00
2132	25x200	30	90.00

SMV-D-7 Tubes, Culture, Media, Round Bottom, with Screw Cap

Cat No.	Approx O.D. X Length mm	Cap.ML	Price
2133	16x75	5	60.00
2134	16x125	10	70.00
2135	25x100	20	75.00
2136	25x200	30	90.00

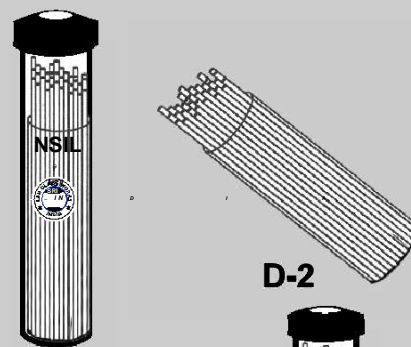

D-1

D-2



D-3



D-4

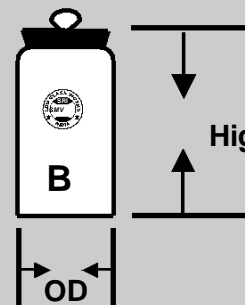

OD

Hight

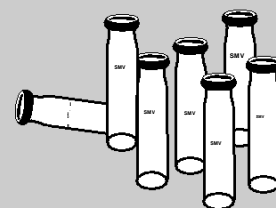

D-5



D-6



D-7



D-8



D-9



D-10

**SMV-D-8 A Tubes .Culture, Media, Round Bottom, With Screw Cap
AMBER COLOUR**

Cat No.	Approx O.D. X Length mm	Cap.ML	Price
2137	16x75	5	80.00
2138	16x125	10	90.00
2139	25x100	20	100.00
2140	25x200	30	100.00

**SMV-D-9 B Tubes. Culture, Media, Flat Bottom, With Screw Cap
AMBER COLOUR**

Cat No.	Approx O.D. X Length mm	Cap.ML	Price
2141	16x75	5	90.00
2142	16x125	10	100.00
2143	25x100	20	110.00
2144	25x200	30	110.00

SMV-D-10 Stirrer blades Teflon

Cat No.	Cap.ml	Size	Price
2145	100	19/26	83.00
2146	100	24/29	83.00
2147	150	19/26	83.00
2148	250	19/26	230.00
2149	250	24/29	230.00
2150	500	24/29	240.00
2151	500	34/35	240.00
2152	1000	24/29	350.00
2153	1000	29/32	350.00
2154	1000	34/35	350.00
2155	2000	24/29	660.00
2156	2000	29/32	660.00
2157	2000	34/35	660.00
2158	3000	24/29	680.00
2159	3000	29/32	680.00
2160	3000	34/35	680.00
2161	5000	29/32	830.00
2162	5000	29/32	830.00
2163	5000	34/35	830.00
2164	10000	34/35	965.00
2165	10000	55/44	965.00
2166	20000	34/35	1,095.00
2167	20000	55/44	1,095.00

SMV-D-11 Mercury Seal Teflon PTFE

Cat No.	Size	Price
2168	8 mm Bore B 19	1,400.00
2169	8 mm Bore B 24	2,050.00
2170	10 mm Bore B 29	2,200.00
2171	10 mm Bore B 34	2,200.00
2172	12 mm Bore B 55	4,500.00

SMV-D-12 Teflon Gland (Stuffing box)

Cat No.	Size	Price
2173	8 mm Bore B 19	700.00
2174	8 mm Bore B 24	800.00
2175	10 mm Bore B 29	900.00
2176	10 mm Bore B 34	1,100.00
2177	12 mm Bore B 55	2,000.00

SMV-D-13 Standard Tapered Clips

Cat No.	Size	Price
2178	B-14	100.00
2179	B-19	120.00
2180	B-24	130.00
2181	B-29	150.00

SMV-D-14 Buchner Funnel (J-Brand)

Cat No.	Size Inch	Grams Ceramic	Price
2182	1"	15	100.00
2183	2"	25	140.00
2184	3"	50	180.00
2185	4"	100	200.00
2186	5"	250	470.00
2187	6"	500	670.00
2188	8"	1000	1,600.00
2189	10"	2000	2,200.00
2190	12"	5000	4,200.00
2191	16"	10000	16,000.00

SMV-D-15 Rubber Tubing Use for

Cat No.	Size	Price
2192	Water Circulation Pipe (1 Bandel = 10 mtr)	600.00
2193	Vacuum Rubber Pipe (1 Bandel = 10 mtr)	1000.00
2193A	Silicon Water Circulation Pipe (1 Bandel = 25 mtr)	P.O.R
2193B	Silicon Vacuum Pipe (1 Bandel = 10 mtr)	P.O.R

SMV-D-16 Rubber Septas

Cat No.	Size	Price
2194	B-14	100.00
2195	B-19	120.00
2196	B-24	140.00
2197	B-29	160.00



D-11

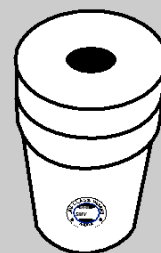

D-12

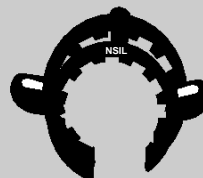

D-13

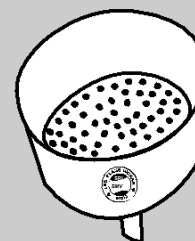

D-14



D-15

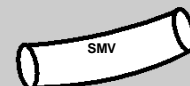

2193 A&B



D-16



D-17

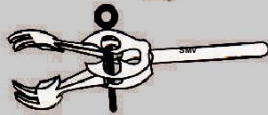
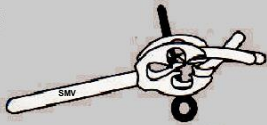

D-18

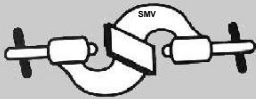

D-19



D-20

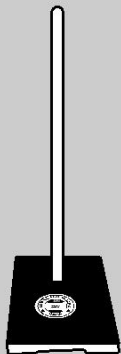

D-21

SMV

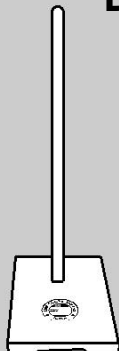

D-22

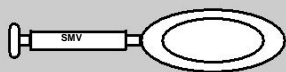

D-23

SMV-D-17 Metro ark Compound Grease

Cat No.	Size	Price
2198	Grease 50 g box	200.00
2199	Grease 1 kg	2,000.00

SMV-D-18 Clamps with boss head

Cat No.	Size	Price
2200	Two finger (Jumbo)	1,600.00
2201	Two finger (Brass)	800.00
2202	Three finger clamps with Rubber Sleeve And boss heads MS	300.00
2203	Four finger clamps with Rubber Sleeve MS And boss heads	300.00
2204	Four finger clamps Brass with Boss heads	850.00
2205	Three finger clamps Brass with Boss heads	850.00

SMV-D-19 Boss Heads for Clamps Rod

Cat No.	Size	Price
2206	15 mm	180.00
2207	20 mm	220.00
2208	25 mm	310.00

SMV-D-20 Powder Sampler SS 316 grade OD

Cat No.	Capacity	Price
2209	26x600 mm	6,500.00
2210	30x1000 mm	7,500.00

SMV-D-21 Retort Stand with heavy M.S. Base and Rod

Cat No.	Rod Size	Price
2215	225x150x750	900.00
2216	300x175x900	1,300.00

SMV-D-22 Retort Stand with heavy SS. Base and Rod

Cat No.	Rod Size	Price
2218	225x150x750 s.s 304	3,600.00
2219	300x175x900 s.s 304	3,600.00

**SMV-D-23 Retort Ring fitted with head Powder for ML
(For Separating funnel (MS))**

Cat No.	Capacity ml	Price
2220	100	400.00
2221	250	450.00
2222	500	450.00
2223	1000	600.00
2224	2000	650.00

SMV-D-24 Retort Ring fitted with head Powder for ML (For Separating funnel (S.S))

Cat No.	Capacity ml	Price
2225	100	700.00
2226	250	800.00
2227	500	800.00
2228	1000	1,000.00
2229	2000	1,000.00

SMV-D-25 Laboratory Jack box M.S.Type

Cat No.	Size CM	Price
2230	15x15	2,600.00
2231	15x20	3,200.00
2232	20x20	3,800.00

SMV-D-26 Laboratory Jack box S.S.type

Cat No.	Size CM	Price
2233	15x15	5,200.00
2234	15x20	5,800.00
2235	20x20	9,200.00

SMV-D-27 Brushes with Nylon Bristles Brush

Cat No.	Model	Price
2236 A	Test Tube Brush Small	25.00
2236 B	Test Tube Brush Big	35.00
2238 C	Burette Brush & Condenser Brush	90.00
2239 D	Flask Brush	105.00

SMV-D-28 Round Magnetic Stirring bar with Center ring

Cat No.	Size mm	Price
2240	5x8	150.00
2241	5x10	150.00
2242	6x12	150.00
2243	6x18	150.00
2244	7x15	150.00
2245	8x20	170.00
2246	8x25	190.00
2247	8x30	210.00
2248	8x50	250.00
2249	9x20	300.00
2250	9x25	300.00
2251	9x35	320.00
2252	10x40	400.00
2253	10x50	450.00
2254	10x60	450.00
2255	13x35	600.00
2256	13x75	650.00



D-24

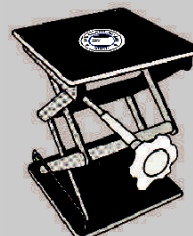

D-25

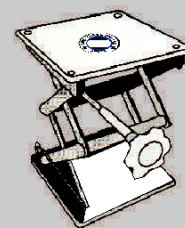

D-26

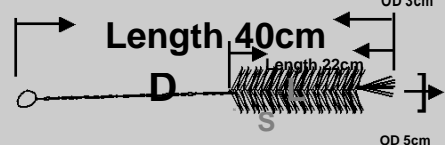
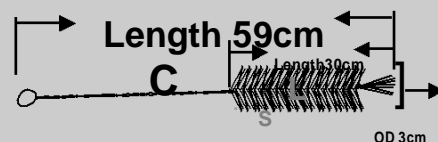
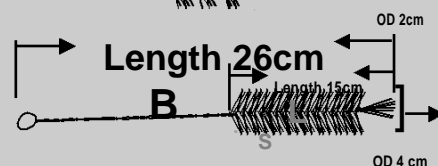

D-27

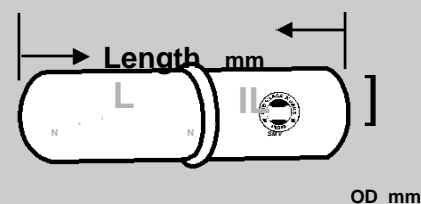

D-28

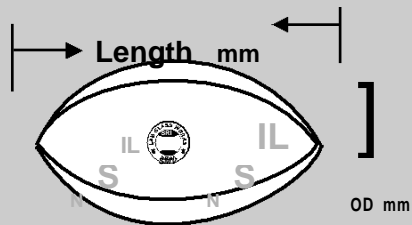

D-29

SMV-D-29 Oval Shape Magnetic Stirring Bar

Cat No.	Size	Price
2257	4x8	220.00
2258	5x10	250.00
2259	6x15	250.00
2260	10x20	300.00
2261	12x25	379.00
2262	16x30	446.00
2263	16x35	694.00
2264	20x40	743.00
2265	20x50	800.00
2266	20x64	990.00
2267	20x70	1,050.00

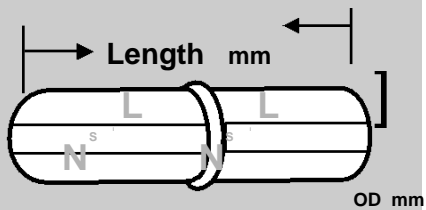

D-30

SMV-D-30 Octagon Magnetic Stirring Bar

Cat No.	Size	Price
2268	8x13	150.00
2269	8x16	150.00
2270	8x25	200.00
2271	8x38	250.00
2272	9x13	200.00
2273	9x19	250.00
2274	9x25	300.00
2275	9x38	350.00
2276	9x51	400.00
2277	13x15	450.00
2278	13x75	650.00

SMV-D-41 Retort Stand PP

Cat No.	Size mm	Price
2343	300x200 Central Hole	970.00
2344	225x150 Side Hole	750.00
2345	300x200 Side Hole	1,000.00

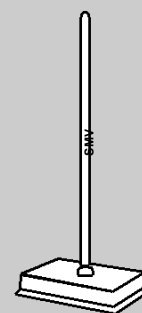

D-41

SMV-D-42 Burette Clamp PP

Cat No.	Size	Price
2351	Single	100.00
2352	Double	170.00

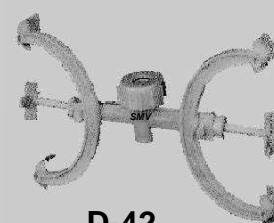

D-42

SMV-D-43 Narrow Mouth Bottles PP autoclavable

Cat No.	Capacity ml	Packing No's	Price Each
2353 A	4	100	8.00
2353 B	8	100	10.00
2353 C	15	100	12.00
2353 D	30	12	18.00
2354	60	12	22.00
2355	125	12	30.00
2356	250	12	48.00
2357	500	12	60.00
2358	1000	6	95.00



D-43

SMV-D-44 Wide Mouth Bottles (PP Autoclavable)

Cat No.	Capacity ml	Packing No's	Price Each
2359	30	12	20.00
2360	60	12	24.00
2361	125	12	34.00
2362	250	12	59.00
2363	500	12	65.00
2364	1000	6	110.00



D-44

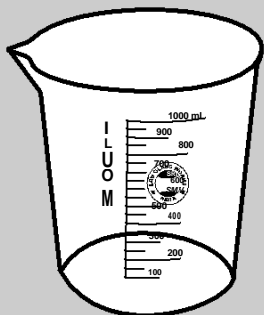

D-45

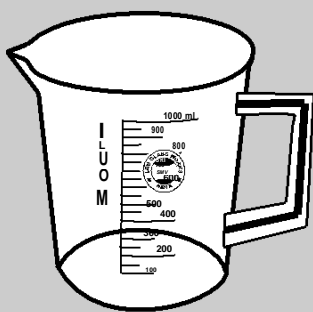

D-46



D-47



D-48

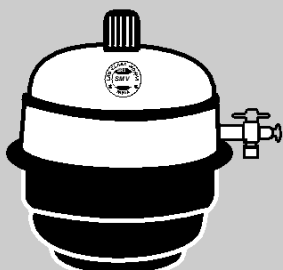

D-49

SMV-D-45 Beaker's Polypropylene PP

Cat No.	Capacity ml	Packing No's	Price Each
2365	50	12	18.00
2366	100	12	20.00
2367	250	12	34.00
2368	500	12	54.00
2369	1000	6	120.00
2370	2000	6	180.00
2371	5000	2	790.00
2372	10000	2	1,200.00

SMV-D-46 Measuring Beaker with Handle PP

Cat No.	Capacity ml.	Packing No's	Price Each
2373	100	12	50.00
2374	250	12	60.00
2375	500	12	70.00
2376	1000	6	130.00
2377	2000	6	210.00
2378	5000	4	850.00

SMV-D-47 Wash Bottles: Polyethylene

Cat No.	Capacity ml	Packing No's	Price Each
2379	125	12	36.00
2380	250	12	52.00
2381	500	6	70.00
2382	1000	6	120.00

SMV-D-48 Wash Bottles (New Type): (Polyethylene)

Cat No.	Capacity ml	Packing No's	Price Each
2383	125	12	52.00
2384	250	12	88.00
2385	500	12	104.00

SMV-D-49 Desiccators (Vacuum): Polyethylene

Cat No.	Capacity mm	Price
2386	150	1,600.00
2387	200	2,500.00
2388	250	4,600.00
2389	300	6,500.00

SMV-D-50 Desiccators (Plain): Polyethylene

Cat No.	Capacity mm	Price
2390	150	1,480.00
2391	200	2,600.00
2392	250	3,600.00
2393	300	6,000.00

SMV-D-51 Measuring Cylinders: Polypropylene PP

Cat No.	Capacity ml	Packing No's	Price Each
2394	10	24	25.00
2395	25	12	39.00
2396	50	12	50.00
2397	100	12	79.00
2398	250	6	105.00
2399	500	4	151.00
2400	1000	3	290.00
2401	2000	2	800.00

SMV-D-52 Funnels-Long stem: Polyethylene PP

Cat No.	Capacity ml	Price
2402	50	10.00
2404	75	18.00
2405	100	35.00

SMV-D-53 Powder Funnels PP

Cat No.	Capacity ml	Price
2407	65	25.00
2408	80	35.00
2409	100	60.00
2410	150	95.00

SMV-D-54 Buchner Funnel: Polyethylene

Cat No.	Capacity mm	Price
2411	70	144.00
2411 A	90	180.00
2412	110	200.00

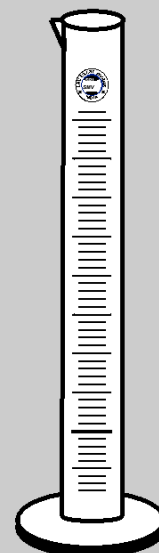
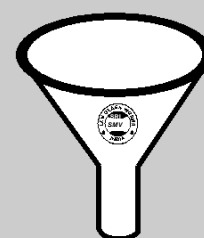
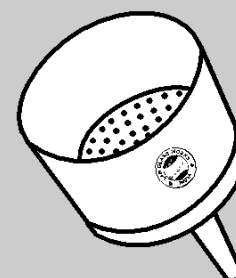
**D-50****D-51****D-52****D-53****D-54**

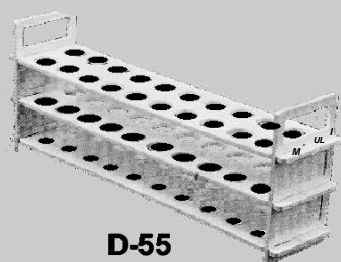

D-55

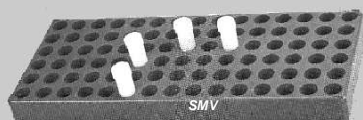

D-56



D-57

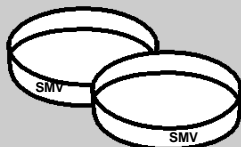

D-58

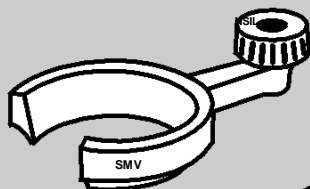

D-59



D-60

SMV-D-55 Test Tube stands (3 Tier): Polypropylene

Cat No.	Size	Price
2413	13 mm x 31 mm	140.00
2414	16 mm x 31 mm	140.00
2415	20 mm x 20 mm	190.00
2416	25 mm x 12 mm	140.00
2417	25 mm x 18 mm	190.00
2418	32 mm x 12 mm	220.00
2419	25 mm x 36 mm	380.00
2420	13 mm x 18 mm	160.00
2421	15 mm x 18 mm	160.00
2422	18 mm x 12 mm	160.00
2423	13 mm x 62 mm	280.00
2424	16 mm x 62 mm	280.00
2425	20 mm x 40 mm	380.00

SMV-D-56 Scintillation Vial Stand

Code	Places	Capacity ml	Price/Pack
2426	90 nos	8	600.00
2427	50 nos	20	630.00

SMV-D-57 Scintillation Vial

Code	Capacity ml	Packing	Price/Pack
2428	8	100	673.00
2429	20	100	730.00

SMV-D-58 Petri Dish PP autoclavable

Cat No.	Size	Price
2430	50 mm	21.00
2431	75 mm	25.00
2432	100 mm	29.00
2433	125 mm	40.00

SMV-D-59 Separating Funnel Holder Single PP

Cat No.	Size	Price
2434	Single PP	110.00
2435	250 mm	246.00
2436	500 mm	325.00

SMV-D-60 Conical Flask Plastic

Cat No.	Capacity ml	Packing No's	Price Each
2437	100 ml	12	70.00
2438	250 ml	12	90.00
2439	500 ml	12	160.00

SMV-D-61 Pipette Stand Horizontal PP

Cat No.	Size	Price
2440	12 Places	200.00

SMV-D-62 Pipette Stand Vertical PP

Cat No.	Size	Price
2441	28 Places	700.00

SMV-D-63 Nestler cylinder Stand PP

Cat No.	Size ml	Price
2442	50	280.00
2443	100	280.00

SMV-D-64 Silica Crucible to withstand Temperature Upto 800 C With out Lid

Cat No.	Capacity ml	Price
2444	15	P.O.R
2445	25	P.O.R
2446	50	P.O.R
2447	80	P.O.R
2448	100	P.O.R
2449	150	P.O.R

SMV-D-65 Silica Crucible to withstand Temperature Upto 800 C with Lid

Cat No.	Capacity ml	Price
2450	15	P.O.R
2451	25	P.O.R
2452	50	P.O.R
2453	80	P.O.R
2454	100	P.O.R
2455	150	P.O.R

SMV-D-66 Silica Basin (Dish) With Spout to withstand temperature upto 800 C

Cat No.	Capacity ml	Price
2456	20	P.O.R
2457	35	P.O.R
2458	70	P.O.R
2459	100	P.O.R
2460	150	P.O.R
2461	200	P.O.R
2462	250	P.O.R

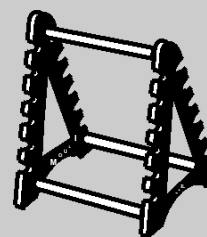

D-61

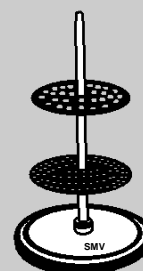

D-62

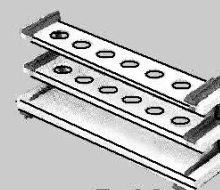

D-63

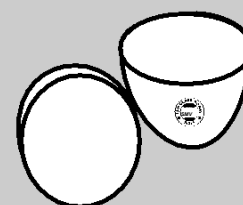

D-64

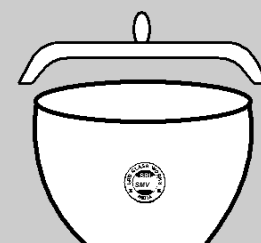

D-65

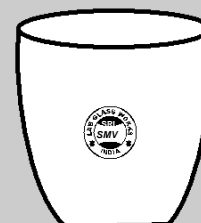

D-66

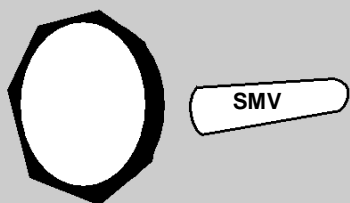

D-68

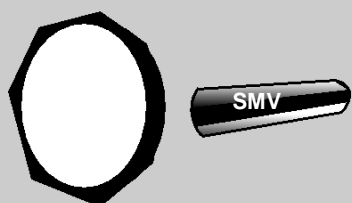

D-69



D-70



D-71



D-71

SMV-D-68 Pestles & Mortars Porcelain

Cat No.	Size (cms)	Price
2470	3	100.00
2471	4	150.00
2472	6	200.00
2473	8	500.00

SMV -D-69 Pestles & Mortars Agate Black

Cat No.	Size (cms)	Price
2474	2	700.00
2475	3	1,100.00
2476	4	1,700.00
2477	5	3,200.00
2478	6	6,000.00

SMV-D-70 Spatulas Flat Spoon Types SS 304

Cat No.	Length Inches	Price
2481	4	44.00
2482	6	60.00
2483	8	70.00
2484	10	140.00
2485	12	150.00

SMV-D-71 Spatulas Rod Type SS 304

Cat No.	Length Inches	Price
2486	4	180.00
2487	6	186.00
2488	8	250.00
2489	10	350.00
2490	12	450.00
2491	18	690.00
2492	24	750.00

SMV-D-71 Spatulas Rod Type SS 304

Cat No.	Length Inches	Price
2486 A	6	90.00
2487 B	8	110.00
2488 C	10	140.00
2489 D	12	160.00

SMV-D-72 RB Base Mode of Silicone Rubber

Cat No.	Capacity ml	Price
2493	25	P.O.R
2494	50	P.O.R
2495	100	P.O.R
2496	250	P.O.R
2497	500	P.O.R
2498	1000	P.O.R
2499	2000	P.O.R
2500	3000	P.O.R
2501	5000	P.O.R
2502	10000	P.O.R
2503	20000	P.O.R

SMV-D-73 Flask Stand RB Base Rubber

Cat No.	Capacity ml	Price
2504	50	300.00
2505	100	300.00
2506	250	350.00

SMV-D-74 Flask Stand RB Base PP

Cat No.	Capacity ml	Price
2507	50 ml to 20 Lit	220.00

SMV-D-75 Laboratory Thermometers (Mercurial) Dimple Make

Cat No	Ranges Degrees	Price
2508	0 to 50	250.00
2509	10 to 110	250.00
2510	0 to 150	250.00
2511	0 to 250	250.00
2512	0 to 360	250.00

SMV-D-76 Laboratory Thermometers (Alcohol)

Cat No.	Ranges	Price
2513	-50 to +50	450.00
2514	-50 to +100	450.00
2515	-100 to+ 50	550.00
2516	-100 to +100	550.00
2517	-150 to +50	550.00

SMV-D-77 FORECEPS Pointed or Flat End

Cat No	Size	Price
2518	4"	70.00
2519	6"	80.00
2520	8"	95.00
2521	10"	115.00
2522	12"	150.00

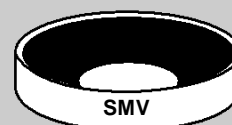

D-72

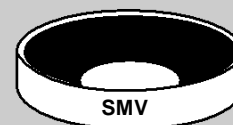

D-73

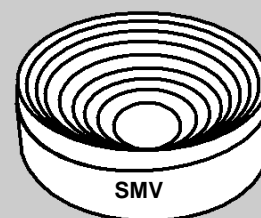

D-74



D-75, 76



D-77

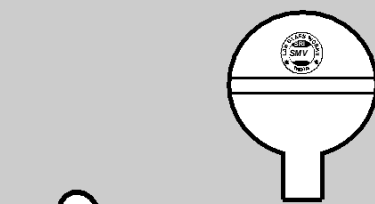

D-78



D-79 A

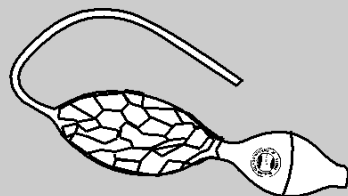

D-79 B

SMV –D-78 Rubber Bulb for (Droppers) Red color

Cat No	Size	Price
2523	Small	P.O.R
2524	Medium	P.O.R
2525	Big	P.O.R

SMV-D-79 Dropping Bottle Rubber Bulb Red Color

Cat No.		Price
2525 A	Dropping Bottle Rubber Bulb Red Color	25.00
2525 B	Chloroform Bulb (Burret Bulb)	550.00

Cat No.	Size Inches	Price
2526	Cannulas 5 mm Bore 24	P.O.R
2527	5 mm Bore 36	P.O.R
2528	1 mm Bore 24	P.O.R
2529	1 mm Bore 36	P.O.R
2530	Spirit Lamp	P.O.R
2531	UV Lamp	P.O.R
2532	Circualtion Pumps Top Model	P.O.R
2533	Circulation Pumps Submarsuble	P.O.R
2534	Butter Paper Ordinary	P.O.R
2535	Filter Paper Ordinary	P.O.R
2536	Whatman Filter Paper	P.O.R
2537	Millipor Filter Paper	P.O.R

SMV -A LAB GEAR STIRRER

CAT No. 1

Lab gear stirrer 630 RPM 12 Volts DC regulator with CI stand SS-316 Rods, back let knobs. Reverse forward direction.(FLP-Model)

SMV -B MAGNETIC STIRRER WIT HOT Plate

CAT No. 2

Lab magnetic stirrer with hot plate (F L P-model) with speed controller Reverse forward directions.

SMV -C Cat.No.3 MS Stand for MAGNETIC STIRRER 10x12xRodx750mm

SMV -D SS -202 Water bath / OIL BATH (REGULATOR FLP Model)

CAT NO 4	500 ml	Capacity Heating oil/water bath with SS-Vessel and energy regulator.
CAT NO 5	1000 ml	Capacity Heating oil/water bath with SS-Vessel and energy regulator
CAT NO 6	2000 ml	Capacity Heating oil/water bath with SS-Vessel and energy regulator
CAT NO 7	3000 ml	Capacity Heating oil/water bath with SS-Vessel and energy regulator
CAT NO 8	5000 ml	Capacity Heating oil/water bath with SS-Vessel and energy regulator
CAT NO 9	10000 ml	Capacity Heating oil/water bath with SS-Vessel and energy regulator
CAT NO 10	20000 ml	Capacity Heating oil/water bath with SS-Vessel and energy regulator

SMV -E SS -304 Digital Heating oil/water bath (FLP Model)

CAT NO 11	500 ml	Capacity Heating oil/water bath with SS-Vessel and energy regulator.
CAT NO 12	1000 ml	Capacity Heating oil/water bath with SS-Vessel and energy regulator
CAT NO 13	2000 ml	Capacity Heating oil/water bath with SS-Vessel and energy regulator
CAT NO 14	3000 ml	Capacity Heating oil/water bath with SS-Vessel and energy regulator
CAT NO 15	5000 ml	Capacity Heating oil/water bath with SS-Vessel and energy regulator
CAT NO 16	10000 ml	Capacity Heating oil/water bath with SS-Vessel and energy regulator
CAT NO 17	20000 ml	Capacity Heating oil/water bath with SS-Vessel and energy regulator

SMV -F SS-316 Digital Heating oil/water bath (FL

Digital Heating oil/water bath. Temp. Accuracy $\pm 2^{\circ}\text{C}$. Maximum Temp. 300°C with 1mm thickness SS-316 Vessel. And Power coated body with heavy duty heating coil.

CAT NO 18	500 ml
CAT NO 19	1000 ml
CAT NO 20	2000 ml
CAT NO 21	3000 ml
CAT NO 22	5000 ml
CAT NO 23	10000 ml
CAT NO 24	20000 ml

SMV -G HEATING MANTLES (CLOTH TYPE)

Heating mantle. Temperature controller by Energy Regulator. Provided with high quality insulation mesh.

CAT NO 25	500 ml
CAT NO 26	1000 ml
CAT NO 27	2000 ml
CAT NO 28	3000 ml
CAT NO 29	5000 ml
CAT NO 30	10000 ml
CAT NO 31	20000 ml



Price /each

Price /each

Price /each

Price /each

SMV –H Laboratory Oven : (HOT AIR MEMMER)

Temperature range 50°C to 250°C temperature accuracy ± 2°C temperature controlled by thermostatic. Inner chamber made of Mild Steel / Stainless Steel and outer chamber made of M.S. / G.I. with powder coating. Heaters placed left and right side in the inner chamber. Digital Temperature indicator cum controller, Air circulation fan with motor. Mesh type trays

CAT NO 32	Size	30X 30 X 30 CM	–	1250 Watts
CAT NO 33	Size	35 X 35 X 35 CM	–	1450 Watts
CAT NO 34	Size	45 X 45 X 45 CM	–	1750 Watts
CAT NO 35	Size	45 X 45 X 60 CM	–	2000 Watts
CAT NO 36	Size	60 X 60 X 60 CM	-	2500 Watts
CAT NO 37	Size	60 X 60 X 90 CM	-	3500 Watts

Price /each

IQ,OQ and Calibration certificate. EXTRA



SMV –H

SMV –I Laboratory Oven SS304 : (HOT AIR GMP)

Double walled construction fully made of Stainless steel Inner S.S.304 & Outer 304. The gap between the two walls filled with glass wool insulation. Temperature controlled by microprocessor based digital temp. Controller with PT100 as sensor & safety thermostat. Supplied with s. s wire mesh shelves and silicon gasket on door .with Air circulation fan Temp. Range: 50 °C to 250 °C accuracy +/-1 °C.

Price /each

CAT NO 38	Size	30X 30 X 30 CM	–	1250 Watts
CAT NO 39	Size	35 X 35 X 35 CM	–	1450 Watts
CAT NO 40	Size	45 X 45 X 45 CM	–	1750 Watts
CAT NO 41	Size	45 X 45 X 60 CM	–	2000 Watts
CAT NO 42	Size	60 X 60 X 60 CM	-	2500 Watts
CAT NO 43	Size	60 X 60 X 90 CM	-	3500 Watts

IQ,OQ and Calibration certificate. EXTRA

SMV –J Laboratory Oven SS316 : (HOT AIR GMP)

Double walled construction fully made of Stainless steel Inner S.S.316 & Outer 304. The gap between the two walls filled with glass wool insulation. Temperature controlled by microprocessor based digital temp. Controller with PT100 as sensor & safety thermostat. Supplied with s. s wire mesh shelves and silicon gasket on door .with Air circulation fan Temp. Range: 50 °C to 250 °C accuracy +/-1 °C.

Price /each

CAT NO 44	Size	30X 30 X 30 CM	–	1250 Watts
CAT NO 45	Size	35 X 35 X 35 CM	–	1450 Watts
CAT NO 46	Size	45 X 45 X 45 CM	–	1750 Watts
CAT NO 47	Size	45 X 45 X 60 CM	–	2000 Watts
CAT NO 48	Size	60 X 60 X 60 CM	-	2500 Watts
CAT NO 49	Size	60 X 60 X 90 CM	-	3500 Watts

IQ,OQ and Calibration certificate. EXTRA



SMV –I,J

SMV –K VACUUM OVEN RECTANGULAR

Vacuum ovens are commonly using the temp range from 50°C to 200°C. The inner chamber is made out of stainless steel and outer of MS Sheet beautifully powder coated. Glass wool insulation is provided all around the chamber to minimize heat loss due to radiation. The door is provided with a glass window to view the samples placed inside. The temperature is controlled and indicated by a digital temperature indicating controller. Vacuum control valve with a vacuum gauge is also provided. Maximum vacuum:760mm of Hg.Mains:220/230V.AC.

Cat No.	INNER Size in Cm W X D X H	Rating Watts	No. of Shelves	Price
CAT NO.50	20 X 20 X 30 Cm	1600	3	
CAT NO.51	30 x 30 x 40 Cm	1750	3	
CAT NO.52	35 x 35 x 50 Cm	2000	4	
CAT NO.53	45 x 45 x 60 Cm	2250	5	



SMV –K



SMV –L

SMV –L Cat No.54 VACUUM OVEN RECTANGULAR GMP Model All Sizes Availab

SMV -M VACUUM OVEN (Round): Digital

Vacuum ovens are commonly using the temp range from 50°C to 200°C. The inner chamber is made out of stainless steel and outer of MS sheet powder coated. Glass wool insulation is provided all around the chamber to heat loss due to radiation. The door is provided with a glass window to view the samples placed inside. **The temp is controlled**

provided. Maximum vacuum: 760mm of Hg. Mains:22/230V.AC

Cat No.	SIZE IN DIA	RATING WATTS	TRAYS	EACH PRICE
Cat No. 55	30X22.5 CM	500	02 No's	
Cat No. 56	30X22.5 CM	500	02 No's	
Cat No. 57	30X22.5 CM	500	02 No's	

SMV -N VACUUM OVEN Round Digital (GMP Mod)

Double walled construction fully made of stainless steel 304Q supplied with vacuum gauge, Vacuum cock, toughened glass window. Temperature controlled Microprocessor based Auto tune PID digital Temperature controller with PT 100 as sensor. Maximum vacuum 760mm of mercury (-30C). Supplied with S.S tray vacuum gauge, vacuum cock.

Cat No.	SIZE IN DIA	RATING WATTS	TRAYS	EACH PRICE
Cat No. 58	30X22.5 CM	500	02 No's	
Cat No. 59	30X22.5 CM	500	02 No's	
Cat No. 60	30X22.5 CM	500	02 No's	

SMV -O MUFFELE FURNACE

Rectangular Horizontal Muffle furnace outer body made of middle steel with powder coating. Maximum working temperature 1130°C. Temp controlled by Digital temperature controller.

Cat No.	INNER SIZE DxHxW	RATING WATTS	EACH PRICE
Cat No. 61	23x10x10 cm	2000	
Cat No. 62	25x13x13 cm	2500	
Cat No. 63	30x15x15 cm	3500	
Cat No. 64	45x23x23 cm	7000	

SMV - P

Cat No. 65 **DIGITAL TEMPERATURE INDICATOR** (FOR HEATING & COOLING INDICATING PURPOSE) **PRICE**

Cat No. 66 **DIGITAL TEMPERATURE CONTROL BOX** (FOR HEATING COILS CONTROL PURPOSE)

SMV -Q UV CABINET 3 BULBS

CAT NO	UV CABINET	3 BULBS	PRICE
CAT NO 67	UV CABINET	3 BULBS	
CAT NO 68	UV LAMPS	CLEAR	
CAT NO 69	UV LAMPS	WHEIT	
CAT NO 70	UV LAMPS	BLACK	

SMV- R LABJACKS M S

CAT NO	SIZE	PRICE
Cat No. 71	Lab Jack M.S 14 x 12 cms	
Cat No. 72	Lab Jack M.S 20 x 20 cms	
Cat No. 73	Lab Jack M.S 25 x 25 cms	
Cat No. 74	Lab Jack M.S 30 x 30 cms	

SMV- S LABJACKS SS 304

CAT No	SIZE	PRICE
CAT No. 75	Lab Jack S.S 14 x 12 cms	
CAT No. 76	Lab Jack S.S 20 x 20 cms	
CAT No. 77	Lab Jack S.S 25 x 25 cms	
CAT No. 78	Lab Jack S.S 30 x 30 cms	

SMV- T POWDER SAMPLERS SS 316

CAT No	SIZE	PRICE
CAT No. 79	2 Feet Length	
CAT No. 80	4 Feet Length	



SMV -M



SMV -N



SMV -O



SMV -Q



SMV -R



SMV -S



SMV -T

